

Lusac®

Raybestos
The best in brakes
TABLA DE APLICACIONES POR LÍNEA DE PRODUCTO

CILINDROS DE RUEDA				
NÚMERO DE PARTE	NÚMERO RAYBESTOS	MEDIDA	APLICACIÓN	FOTO PÁGINA
LC-746	WC-37317	38.1 mm 1-1/2"	Chrysler Dodge Camion 500, 600 58-67	580
LC-834	-----	19.0 mm 3/4"	Chevrolet Tras. Izq. Der. Chevy Joy, Swing 96-03, Monza 97-03, Chevy Pop 94-03, Chevy Vagoneta 00 -03, Chevrolet Tras. Izq. Der. Corsa 02-07, Corsa Sedan 03-07, Astra 00-03 1.8L, Meriva 04-07, Tigra 99, Vectra 03-05, Zafira 02-06	580
LC-844	N/D	19.0 mm 3/4"	Chevrolet Chevy C2, 2 puertas 04-10, Chevy C2 Sedan 4 puertas 05 - 07, Chevrolet Tras. Izq. Der. Chevy Joy, Swing 94-03, Monza 97-03, Chevy Pop 96-03, Chevy Vagoneta 00 -03,	580
LC-1012	WC-1012	44.4 mm 1-3/4"	Chrysler Del. Izq. Der. Camión 3, 4 y 5 Toneladas 48-57	580
LC-1430	WC-4571	34.9 mm 1-3/8"	Ford Tras. Izq. y Der. Camioneta. F-350 46/52.	580
LC-3406	WC-3406	31.7 mm 1-1/4"	Chevrolet Del. Izq. Der. Camion 40 36-50, 60 47-50	580
LC-3730	WC-3730	31.7 mm 1-1/4"	Chevrolet Del. Der. Pasajeros 38-51	580
LC-3731	WC-3731	31.7 mm 1-1/4"	Chevrolet Del. Izq. Camion Pasajeros 36-48	580
LC-4419	WC-4419	34.9 mm 1-3/8"	Chevrolet Del. Der. G.M.C. Camion 47-49	580
LC-4511	WC-4511	38.1 mm 1-1/2"	Ford Tras. Izq. Der. F-300, 350 48-49, F- 500-600 40-52	580
LC-7379	WC-7379	25.4 mm 1"	VAM Del. Izq. Jeep Willys 42-53	580
LC-8852	WC-8852	28.5 mm 1-1/8"	Chevrolet Del. Izq. C-50 70-72, C-60 70-88, C-65 79-85.	580
LC-8853	WC-8853	28.5 mm 1-1/8"	Chevrolet Del. Der. C-50 70-72, C-60 70-88, C-65 79-85.	580
LC-9090	WC-9090	26.9 mm 1-1/16"	Ford Del. Izq. F-100 70-71.	580
LC-9091	WC-9091	26.9 mm 1-1/16"	Ford Del. Der. F-100 70-71.	580
LC-9336	WC-7563	25.4 mm 1"	Chevrolet Tras. Izq. Camioneta. G-35 1971 USA.	580
LC-9337	WC-7564	25.4 mm 1"	Chevrolet Tras. Der. Camioneta. G-35 1971 USA.	581
LC-9344	WC-9344	31.7 mm 1-1/4"	Chevrolet Tras. Izq. C-30, 35 70., Chrysler D-300 70-71	581
LC-9345	WC-9345	31.7 mm 1-1/4"	Chevrolet Tras. Der. C-30, 35 70., Chrysler D-300 70-71	581
LC-10028	WC-10028	20.6 mm 13/16"	VAM Tras. Izq. Der. Jeep Willys 61-64	581
LC-10580	WC-10580	28.5 mm 1-1/8"	Chrysler Del. Izq. Dodge Camioneta. D-100 , 150, 200 y 250 48-53	581
LC-10581	WC-10581	28.5 mm 1-1/8"	Chrysler Del. Der. Dodge Camioneta. D-100 , 150, 200 y 250 48-53	581
LC-10582	WC-10582	28.5 mm 1-1/8"	Chrysler Del. Izq. Dodge Camioneta. D-100, 150 57-58	581
LC-10583	WC-10583	28.5 mm 1-1/8"	Chrysler Del. Der. Dodge Camioneta. D-100, 150 57-58	581
LC-10588	WC-10588	28.5 mm 1-1/8"	Chrysler Tras. Der. Dodge Camion Modelo Early 46-56	581
LC-13368	WC-13368	26.9 mm 1-1/16"	Chrysler Dodge D-500 72-77, D- 600 70-77, Del. Izq.	581
LC-13369	WC-13369	26.9 mm 1-1/16"	Chrysler Dodge D-500 72-77, D- 600 70-77, Del. Der.	581
LC-13387	WC-13387	25.4 mm 1"	Chevrolet Tras. Izq. C-10 70-73, C-30, C-35 71-73, VAM Tras. Izq. Wagoneer J-164 70-73	581
LC-13388	WC-13388	25.4 mm 1"	Chevrolet Tras. Der.. C-10 70-73, C-30, C-35 71-73, VAM Tras. Der. Wagoneer J-164 70-73	581
LC-14068	WC-14068	25.4 mm 1"	VAM Tras. Izq. Ambassador 65-70, Classic 65-66, Jeep Willys 50-64	581
LC-14069	WC-14069	25.4 mm 1"	VAM Tras. Der. Ambassador 65-70, Classic 65-66, Jeep Willys 50-64	581
LC-14205	WC-14205	28.5 mm 1-1/8"	Chevrolet Del. Izq. Camioneta K-10 60-63	581
LC-14206	WC-14206	28.5 mm 1-1/8"	Chevrolet Del. Der. Camioneta K-10 60-63	582
LC-14493	WC-14493	28.5 mm 1-1/8"	Chevrolet Del. Izq. C-10 51-54, C-20 65-69, C-30 55,	582
LC-14494	WC-14494	28.5 mm 1-1/8"	Chevrolet Del. Der. C-10 51-54, C-20 65-69, C-30 55,	582
LC-15306	WC-15306	34.9 mm 1-3/8"	I.H.C. Tras. Izq- Der. Camion Serie 140 58-62	582
LC-15307	WC-15307	38.1 mm 1-1/2"	I.H.C. Tras- Izq. Camion Serie 160 62-82	582
LC-15308	WC-15308	38.1 mm 1-1/2"	I.H.C. Tras- Der. Camion Serie 160 62-82 Baja	582
LC-15315	WC-15315	38.1 mm 1-1/2"	Chevrolet Del. Der. G.M.C. Camion 400 50-54	582
LC-16534	WC-16534	25.4 mm 1"	VAM Del. Jeep Willys 50-64	582



TABLA DE APLICACIONES POR LÍNEA DE PRODUCTO

CILINDROS DE RUEDA				
NÚMERO DE PARTE	NÚMERO RAYBESTOS	MEDIDA	APLICACIÓN	FOTO PÁGINA
LC-16535	WC-16535	19.0 mm 3/4"	VAM Tras. Der. Jeep Willys 53-65	582
LC-17507	WC-17507	22.2 mm 7/8"	Chrysler Tras Izq. Durango 98, D-250 86-87, D-350 88-90, Microbus 88-90, Jeep Grand Cherokee 93-98, W-250 4X4 86-93, Ram Van 3500 95-97, Ram Wagon 3500 95-97, Ford Maverick 74-77, Mustang 71-73, F-100 70-79, VAM American 70 y 74-83, Classic 74-76, Gremlin 77-83, Javelin 70, Pacer 76-78, Rally 71-76, Jeep CJ-5 76-86, Jeep CJ-7 82-84, Wagoneer 84-86	582
LC-17508	WC-17508	22.2 mm 7/8"	Chrysler Tras Der. Durango 98, D-250 86-87, D-350 88-90, Microbus 88-90, Jeep Grand Cherokee 93-98, W-250 4X4 86-93, Ram Van 3500 96-97, Ram Wagon 3500 96-97, Ford Maverick 74-77, Mustang 71-73, F-100 70-79, VAM American 70 y 74-83, Classic 74-76, Gremlin 77-83, Javelin 70, Pacer 76-78, Rally 71-76, Jeep CJ-5 76-86, Jeep CJ-7 82-84, Wagoneer 84-86	582
LC-17786	WC-17786	38.1 mm 1-1/2"	Chrysler Tras. Izq. Der. Dodge Camion 400-700 57-68.	582
LC-18179	WC-36074	28.5 mm 1-1/8"	Chrysler Del. Izq. Dodge D-300 70.	582
LC-18180	WC-36075	28.5 mm 1-1/8"	Chrysler Del. Der. Dodge D-300 70.	582
LC-18196	WC-18196	38.1 mm 1-1/2"	Chevrolet Tras. Izq. C-40, C-50, C-60 53-65	584
LC-18197	WC-18197	38.1 mm 1-1/2"	Chevrolet Tras. Der. C-40, C-50, C-60 53-65	583
LC-18290	WC-18290	28.5 mm 1-1/8"	Ford Del. Izq. F-100 70-71, VAM Jeep DJ-5 70-73, Wagoneer J-164 70-73	583
LC-18291	WC-18291	28.5 mm 1-1/8"	Ford Del. Der. F-100 70-71, VAM Jeep DJ-5 70-73, Wagoneer J-164 70-73	583
LC-18984	WC-37218	26.9 mm 1-1/16"	Chrysler Tras. Izq. D-350 Microbus 81-87, Ford F-350 71-83, P-350 Microbus 72-78.	583
LC-18985	WC-37219	26.9 mm 1-1/16"	Chrysler Tras. Der. D-350 Microbus 81-8, Ford F-350 71-83, P-350 Microbus 72-78.	583
LC-19107	WC-19107	41.3 mm 1-5/8"	Chrysler Tras. Izq. Der. Dodge 600,700 57-58	583
LC-19109	WC-19109	44.4 mm 1-3/4"	Ford Tras. Der. Camion 700 57-64	583
LC-19111	WC-19111	47.6 mm 1-7/8"	Chevrolet Tras. Der. Camion 60 79-84	583
LC-19746	WC-19746	38.1 mm 1-1/2"	Ford Tras. Izq. Der. F - 600 80-82.	583
LC-20932	WC-20932	28.5 mm 1-1/8"	Chevrolet Del. Izq. Camioneta C-10 60-63, P-10 61-63	583
LC-20933	WC-20933	28.5 mm 1-1/8"	Chevrolet Del. Der. Camioneta C-10 60-63, P-10 61-63	583
LC-24489	WC-24489	41.3 mm 1-5/8"	Chevrolet Del. Izq. Sup. & Inf. Tras. C-50 70-72, C-60 70-88, C-65 79-85, Chrysler D-500 70-77, D-600 70-77, Ford B-600, F-600 70-79	583
LC-24954	WC-24954	28.5 mm 1-1/8"	Chrysler Del. Der. Dodge D-100 70-71. D-300 71	583
LC-24955	WC-24955	28.5 mm 1-1/8"	Chrysler Del. Izq. Dodge D-100 70-71. D-300 71	583
LC-25459	WC-25459	41.3 mm 1-5/8"	Chevrolet Tras. Izq. C-60, C-70 65-67 (Superior), Chrysler Dodge 500,600 65-68, Ford Camión Varios 61-68	583
LC-25460	WC-25460	41.3 mm 1-5/8"	Chevrolet Tras. Der. C-60, C-70 65-67 (Superior), Chrysler Dodge 500,600 65-68 (Superior), Ford Camión Varios 61-68 (Superior)	583
LC-25463	WC-25463	41.3 mm 1-5/8"	Chevrolet Tras. Izq. C-60, C-70 65-67, Chrysler Dodge 500,600 65-68, Ford Camión Varios 61-68 (Inferior)	583
LC-25464	WC-25464	41.3 mm 1-5/8"	Chevrolet Tras. Der. C-60, C-70 65-67, Chrysler Dodge 500,600 65-68, Ford Camión Varios 61-68 (Inferior)	584
LC-26159	WC-37180	38.1 mm 1-1/2"	Ford Tras. Izq. Der. Camion B-600, F-600, 84-88	584
LC-26172	WC-26172	44.4 mm 1-3/4"	Chevrolet Tras. Izq. Der. Camion C- 60 70-88, C65 79-85	584
LC-27342	WC-27342	38.1 mm 1-1/2"	Chrysler Tras. Izq. Der. Dodge D-600 70-77.	584
LC-28661	WC-28661	38.1 mm 1-1/2"	Chrysler Tras. Izq. Der. Dodge D-500 70-71, D-600 . 70-77.	584
LC-28720	WC-28720	28.5 mm 1-1/8"	Chrysler Del. Der. Dodge Camioneta. D-100, 150, 200, 250 60-64, D-300, 350 63-68	584
LC-28721	WC-28721	28.5 mm 1-1/8"	Chrysler Del. Izq. Dodge Camioneta. D-100, 150, 200, 250 60-64, D-300, 350 63-68	584
LC-28803	WC-28803	38.1 mm 1-1/2"	Chrysler Del. Izq. Der. Dodge Camion D-600 1970-77, D- 500,900, 57-68.	584
LC-28804	WC-36019	23.0 mm 29/32"	Ford Tras. Izq. Mustang 70-72	584

CILINDROS DE RUEDA



Lusac



Raybestos
The best in brakes

TABLA DE APLICACIONES POR LÍNEA DE PRODUCTO

CILINDROS DE RUEDA				
NÚMERO DE PARTE	NÚMERO RAYBESTOS	MEDIDA	APLICACIÓN	FOTO PÁGINA
LC-28805	WC-36020	23.0 mm 29/32"	Ford Tras. Der. Mustang 70-72.	584
LC-28850	WC-28850	38.1 mm 1-1/2"	Ford Tras. Izq. Der. Camion D-600 70-77.	584
LC-32349	WC-37091	31.7 mm 1-1/4"	Chevrolet Del. Izq. Camion C-60 70, 83-88, C-65 79-85.	584
LC-32350	WC-37092	31.7 mm 1-1/4"	Chevrolet Del. Der. Camion C-60 70, 83-88, C-65 79-85.	584
LC-32357	WC-37248	34.9 mm 1-3/8"	Chevrolet Del. Izq. Camion C-60 71-88.	584
LC-32358	WC-37249	34.9 mm 1-3/8"	Chevrolet Del. Der. Camion C-60 71-88.	584
LC-32555	WC-32555	28.5 mm 1-1/8"	Chrysler Tras. Der. Dodge Monaco 60-61.	584
LC-32864	WC-17789	34.9 mm 1-3/8"	Chrysler Del. Izq. Der. Dodge Camion D-500, 600 53-56, Camioneta. D-100, D-150 57-58.	585
LC-34072	WC-36043	23.8 mm 15/16"	Ford Del. Izq. Camion Ford F- 450, F-500 57-69.	585
LC-34073	WC-36044	23.8 mm 15/16"	Ford Del. Der. Camion Ford F- 450, F-500 57-69.	585
LC-34177	WC-34177	25.4 mm 1"	Chrysler Del. Izq. Dart 63-66 , Valiant 60-66 , 60-63 Rambler.	585
LC-34178	WC-34178	25.4 mm 1"	Chrysler Del. Der. Dart 63-66 , Valiant 60-66 , 60-63 Rambler.	585
LC-34333	WC-19086	28.5 mm 1-1/8"	Chevrolet Del. Izq. Camioneta. C-30, C-35 70-71.	585
LC-34334	WC-19087	28.5 mm 1-1/8"	Chevrolet Del. Der. Camioneta. C-30, C-35 70-71.	585
LC-34401	WC-19090	22.2 mm 7/8"	Chevrolet Del. Izq. Camion C-40 70-72, C-50 73-88.	585
LC-34402	WC-19091	22.2 mm 7/8"	Chevrolet Del. Der. Camion C-40 70-72, C-50 73-88.	585
LC-34474	WC-34474	28.5 mm 1-1/8"	Chevrolet Tras. Izq. C-30, C-35 71	585
LC-34475	WC-34475	28.5 mm 1-1/8"	Chevrolet Tras. Der. C-30, C-35 71	585
LC-34876	WC-34876	20.6 mm 13/16"	Chrysler Tras. Izq. Der. Dart 70-76, Valiant Duster 70-76, Ford Mustang 79-81, Ranger 01-03., VAM Gremlin 74-76, Ford Mustang 79-81, Ranger 01-03.	585
LC-35325	WC-36057	28.5 mm 1-1/8"	Chevrolet Tras. Izq. C-30, C-35 73, Chrysler D-250 86-87, D-350 Microbus 90-93, Ford F-100 72, F-200 87-89, F-350 84-86	585
LC-35326	WC-36058	28.5 mm 1-1/8"	Chevrolet C-30, C-35 73, Chrysler Tras. Der. D-250 86-87, D-350 Microbus 90-93, Ford F-100 72, F-200 87-89, F-350 84-86	585
LC-37080	WC37080	25.4 mm 1"	Chevrolet Tras. Izq. Der. Impala 70, C-10 74-78, C-15 82-87, C-20,25 79-87, C-30, 35 74-75, Suburban 87.	585
LC-37208	WC-37208	19.0 mm 3/4"	Nissan Tras. Izq. Der. Pick Up Doble Cabina 82-96, Pick Up Estaquitas 70-72, y 87-94 Cil. Tokico	585
LC-37209	WC-37209	20.6 mm 13/16"	Nissan Del. Izq. Der. Pick Up Estaquitas 70-72, y 95-03, Pick Up D-21 02-03, Cil. Nabco	586
LC-37210	WC-37210	20.6 mm 13/16"	Nissan Tras. Izq. Der. Pick Up Estaquitas 70-86 Cil. Nabco	586
LC-37250	WC-37250	30.1 mm 1-3/16"	Ford Tras. Izq. Econoline E-350 98, P-350 Microbus 97.	586
LC-37251	WC-37251	30.1 mm 1-3/16"	Ford Tras. Der. Econoline E-350 98, P-350 Microbus 97.	586
LC-37271	WC-37271	25.4 mm 1"	Ford Tras. Izq. Der. Galaxie 73-74, LTD 75-78	586
LC-37274	WC-37274	20.6 mm 13/16"	Nissan Tras. Izq. Der. Datsun Sedan 73-82, Sakura 82.	586
LC-37276	WC37276	19.0 mm 3/4"	Toyota Tras. Izq. Der. Carina 72-73, Celica 71-74. Corolla 70-74. USA	586
LC-37277	WC37277	20.6 mm 13/16"	Toyota Tras. Izq. Der. Corolla 75-79. USA	586
LC-37320	WC37320	25.4 mm 1"	Ford Del. Izq. Courier 72-81 USA	586
LC-37322	WC37322	20.6 mm 13/16"	Ford Tras. Izq. Courier 72-76 USA	586
LC-37323	WC37323	20.6 mm 13/16"	Ford Courier Tras. Der. 72-76 USA	586
LC-37336	WC37336	19.0 mm 3/4"	Chrysler Dodge Tras. Izq. Der. Colt 78-79, Plymouth Arrow 76-80, Hyundai Pony 85-91 USA	586
LC-37358	WC37358	17.4 mm 11/16"	Nissan Tras. Izq. Der. Tsubame 93-04 Nacional, Nissan 310 79-82. F-10 76-78. Sentra 87-90. Stanza 86. USA	586
LC-37375	WC37375	17.4 mm 11/16"	Toyota Tras. Izq. Der. Pickup 75- 83 USA	586

CILINDROS DE RUEDA



TABLA DE APLICACIONES POR LÍNEA DE PRODUCTO

CILINDROS DE RUEDA				
NÚMERO DE PARTE	NÚMERO RAYBESTOS	MEDIDA	APLICACIÓN	FOTO PÁGINA
LC-37376	WC37376	19.0 mm 3/4"	Chrysler Dodge Tras. Izq. Der. Colt 81-91, Plymouth Champ 79-82, Hyundai Excel 86-89, Mitsubishi Mirage 85-88, Precis 87-89. USA	586
LC-37377	WC37377	19.0 mm 3/4"	Chrysler Dodge Tras. Izq. Y Der. D50 79-86, Plymouth Truck Arrow 79-82, Mitsubishi Pickup 83-86, USA	586
LC-37382	WC37382	19.0 mm 3/4"	Nissan Del. Izq. pick up 620 72-77. USA	587
LC-37404	WC37404	19.0 mm 3/4"	Toyota Tras. Izq. Der. Celica 82-85 USA	587
LC-37405	WC37405	22.2 mm 7/8"	Nissan 200SX 84-85; Nissan 280Z 77-78, Nissan 810/810 Maxima 81-84, Nissan Maxima 82-84 Tras Izq Der USA	587
LC-37407	WC-37407	20.6 mm 13/16"	Nissan Tras. Izq. Der. Ninja Turbo 86-87, Sakura 83-86, Samurai 84-87, Ichi Van 87-94	587
LC-37412	WC37412	20.6 mm 13/16"	Mazda 626 79- 80 USA	587
LC-37420	WC37420	22.2 mm 7/8"	Toyota Tras. Izq. Der. Pickup 79-93., Toyota Previa 91-96. USA	587
LC-37438	WC37438	22.2 mm 7/8"	Saturn Coupe SC1, SC2 91-02, Saturn Sedan SL1, SL2 91-02, Saturn Wagon SW1, SW2, SWP 91-02 Tras Izq Der USA	587
LC-37459	WC37459	23.8 mm 15/16"	Toyota Tras. Izq. Der. Pickup 79-93. USA	587
LC-37476	WC37476	25.4 mm 1"	Ford Del. Izq. Der. Courier 77-81 USA	587
LC-37499	WC37499	15.8 mm 5/8"	Nissan Tras. Izq. Der. pick up 620 81-88. USA	587
LC-37509	WC37509	15.8 mm 5/8"	Nissan Tras. Izq. Der .pick up 720 80-81, USA	587
LC-37529	WC37529	20.6 mm 13/16"	Ford Tras. Izq. Escort 83-90, Mercury LN7 83, Lynx 83-87 USA	587
LC-37530	WC37530	20.6 mm 13/16"	Ford Tras. Der. Escort 83-90, Mercury LN7 83, Lynx 83-87 USA	587
LC-37535	WC-37535	16.0 mm	Chevrolet Tras. Izq. Der. Celebrity 82.	587
LC-37539	WC37539	25.4 mm 1"	Chevrolet Tras. Izq. Der. LUV 81-82, Isuzu Pickup 81-83 Y 91-92, USA	587
LC-37548	WC37548	19.0 mm 3/4"	Mazda Tras. Izq. RX7 81-85. USA	587
LC-37549	WC37549	19.0 mm 3/4"	Mazda Tras. Der. RX7 81-85. USA	588
LC-37569	WC-37569	17.4 mm 11/16"	Nissan Tras. Izq. Der. Samurai 81-84	588
LC-37571	WC37571	17.4 mm 11/16"	Nissan Tras. Izq. Der. pick up 720 82-86, pick up D21 86-89 USA	588
LC-37573	WC37573	20.6 mm 13/16"	Hyundai Tras. Izq. Der. Excel 90-91, Scoupe 91-92, Mitsubishi Precis 90-91, Renault Alliance 84-86, Encore 85-86, GTA 87 USA	588
LC-37574	WC-37574	19.0 mm 3/4"	Ford Tras. Izq. Der. Ranger 96-00, Tambor 9"	588
LC-37575	WC37575	19.0 mm 3/4"	Mazda Tras. Izq. Der. 323 86-87, 626 83-87 USA	588
LC-37577	WC37577	19.0 mm 3/4"	Geo Tras. Izq. Der. Prizm 90-92, Toyota Celica 90-91, Corolla 88-92 USA	588
LC-37581	WC37581	19.0 mm 3/4"	Acura Tras. Izq. Integra 86-89, Honda Civic 80-89, Honda CRX 84-89, Honda Prelude 82 USA	588
LC-37582	WC37582	19.0 mm 3/4"	Acura Tras. Der. Integra 86-89, Honda Civic 80-89, Honda CRX 84-89, Honda Prelude 82 USA	588
LC-37584	WC37584	19.0 mm 3/4"	Honda Tras. Izq. Der. Accord 82-85, Honda Prelude 83 USA	588
LC-37585	WC37585	19.0 mm 3/4"	Chevrolet Tras. Izq. Der. 83-87 Celebrity, 83-87 Century, 83-87 Ciera, 85-86 Deville/Concours, 85-86 Electra, 85-86 Fleetwood, 85-86 Oldsmobile 98, Park Avenue 85-86, Pontiac 6000 83-87 USA	588
LC-37595	WC37595	19.0 mm 3/4"	Mazda Tras. Izq. Pickup B-2000, B-2200 83-84. USA	588
LC-37599	WC37599	22.2 mm 7/8"	Isuzu Tras. Izq. Der. Pickup Rodeo 89-97. Amigo 89-93. Trooper II 84-87. USA	588
LC-37601	WC37601	20.6 mm 13/16"	Chrysler Tras. Izq. . Dodge Trk. D50, Ram 50, 83-86, . Raider 87, Mitsubishi Montero, 83-86 Mitsubishi Van 87-90 USA	588
LC-37602	WC37602	20.6 mm 13/16"	Chrysler Tras. Der. Dodge Trk. D50, Ram 50 83-86, Raider 87, Mitsubishi Montero, 83-86 Mitsubishi Van 87-90 USA	588
LC-37604	WC37604	14.2 mm 9/16"	Nissan Tras. Izq. Der. pick up 720 80-83, Nissan pick up D-21 86 USA	588
LC-37619	WC37619	19.0 mm 3/4"	Mazda Tras. Der. Pickup B-2000, B-2200 83-84. USA	589
LC-37625	WC37625	19.0 mm 3/4"	Chevrolet Tras. Izq. Der. Camaro 84-88, Pontiac Firebird 84-88 USA	589

CILINDROS DE RUEDA



Lusac



Raybestos
The best in brakes

TABLA DE APLICACIONES POR LÍNEA DE PRODUCTO

CILINDROS DE RUEDA				
NÚMERO DE PARTE	NÚMERO RAYBESTOS	MEDIDA	APLICACIÓN	FOTO PÁGINA
LC-37626	WC37626	15.8 mm 5/8"	Nissan Tras. Izq. Der. Pick up 720 83-86, Nissan Pick up D21 86 , USA	589
LC-37631	WC37631	20.6 mm 13/16"	Toyota Del . Izq. Der. Pickup 79-84. USA	589
LC-37634	WC37634	19.0 mm 3/4"	Ford Tras. Izq. Der. Bronco II 84-90, Ranger 90-92, 86-84, Mazda Mazda Truck Pickup 94-96 USA	589
LC-37635	WC37635	19.0 mm 3/4"	Geo Tras. Der. Prizm 90-92, Toyota Celica 90-91, Corolla 88-92 USA	589
LC-37636	WC37636	19.0 mm 3/4"	Geo Tras. Izq. Prizm 90-92, Toyota Celica 90-91, Corolla 88-92 USA	589
LC-37637	WC37637	17.4 mm 11/16"	Geo Tras Izq. Prizm 93-96, Toyota Corolla 85-99 USA	589
LC-37640	WC37640	20.6 mm 13/16"	Ford Tras. Izq. Der. Bronco II 84-90, Ranger 84-86 y 90-92, Mazda Pickup 94-96 USA	589
LC-37643	WC37643	20.6 mm 13/16"	Jeep Cherokee 81-83, Jeep Grand Wagoneer 84-93, Jeep J10, J20 87-90, Jeep Wagoneer 81-873 Tras Izq Der USA	589
LC-37644	WC37644	22.2 mm 7/8"	Chevrolet Tras. Izq. Der. S, T Blazer 83-88, S, T10 Pickup 82-88, GMC S, T Jimmy 83-88, S, T15 Pickup 82-88 USA	589
LC-37646	WC37646	17.4 mm 11/16"	Geo Tras. Der. Prizm 89-97, Toyota Corolla 88-89, Tercel 83-99, Paseo 92-97. USA	589
LC-37647	WC37647	19.0 mm 3/4"	Chevrolet Camaro 84-92, Pontiac Firebird 84-92 USA	589
LC-37654	WC37654	22.2 mm 7/8"	Toyota Tras. Izq. Der. Pickup 85-93. USA	589
LC-37660	WC-37660	22.2 mm 7/8"	Ford Tras. Izq. Der. Focus LX, SE, ZTS, Wagon 02-04, Focus Zx3 00-04	589
LC-37663	WC37663	20.6 mm 13/16"	Ford Tras. Izq. Der. Aerostar Van 86-89, Ranger 87-94, Mazda Pickup 94 USA	589
LC-37664	WC37664	17.4 mm 11/16"	Chevrolet Tras. Izq. Der. Spectrum 85-88, Geo Spectrum 89, Isuzu I-Mark 85-89 USA	590
LC-37684	WC-37684	23.8 mm 15/16"	Nissan Tras. Izq. Der. Pick Up Estaquitas 87-03, Pick Up D-21 92-03, Chasis Largo 97-03.	590
LC-37685	WC-37685	15.8 mm 5/8"	Nissan Tras. Izq. Der. Sentra USA 86-90	590
LC-37686	WC-37686	17.4 mm 11/16"	Nissan Tras. Izq. Der. Trk. D21 86-89 4 Whell Drive USA.	590
LC-37687	WC37687	19.0 mm 3/4"	Toyota Tras. Izq. Camry 87-91 USA	590
LC-37688	WC37688	19.0 mm 3/4"	Toyota Tras. Der Camry 87-91 USA	590
LC-37690	WC37690	25.4 mm 1"	Chevrolet Celebrity 84-87, Century 84-87, Ciera 84-87, Pontiac 6000 84-87 Tras Izq Der USA	590
LC-37692	WC-37692	17.4 mm 11/16"	Nissan Tras. Izq. Der. Trk. 720 83-85, Trk. D21 86-89 Equipo Pesado Dual Wheels USA	590
LC-37693	WC-37693	19.0 mm 3/4"	Nissan Tras. Izq. Der. Altima 96-00	590
LC-37694	WC37694	19.0 mm 3/4"	Chevrolet Tras. Izq. Der. Beretta 87-91 USA	590
LC-37696	WC37696	20.6 mm 13/16"	Chrysler Dakota 87-93. USA	590
LC-37697	WC-37697	19.0 mm 3/4"	Ford Tras. Izq. Thunderbird 85-88.	590
LC-37698	WC-37698	19.0 mm 3/4"	Ford Tras. Der. Thunderbird 85-88.	590
LC-37707	WC37707	20.6 mm 13/16"	Honda Tras. Izq. Der. Honda Accord 86-88. USA	590
LC-37708	WC37708	22.2 mm 7/8"	Chrysler Tras. Izq. Mitsubishi Montero Sport 03-04 Nacional, Dodge Power Ram 50 87-88, Ram 50 87-88, Mitsubishi Pickup 87-88 USA	590
LC-37709	WC37709	22.2 mm 7/8"	Chrysler Tras. Der. Mitsubishi Montero Sport 03-04 Nacional, Dodge Power Ram 50 87-88, Ram 50 87-88, Mitsubishi Pickup 87-88 USA	590
LC-37710	WC37710	23.8 mm 15/16"	Chrysler Tras. Izq. Dodge Power Ram 50 87-88, Ram 50 87-88, Mitsubishi Pickup 87-88, USA	591
LC-37711	WC37711	23.8 mm 15/16"	Chrysler Tras. Der. Dodge Power Ram 50 87-88, Ram 50 87-88, Mitsubishi Pickup 87-88, USA	591
LC-37751	WC37751	19.0 mm 3/4"	Mazda Tras. Der. Pickup B-2000 86-87, B-2200 83-93. B-2600 86-93. USA	591
LC-37752	WC37752	19.0 mm 3/4"	Mazda Tras. Izq. Pickup B-2000 86-87, B-2200 83-93. B-2600 86-93. USA	591
LC-37779	WC-37779	19.0 mm 3/4"	Chevrolet Tras. Izq. Der. Silhouette 91	591

CILINDROS DE RUEDA



TABLA DE APLICACIONES POR LÍNEA DE PRODUCTO

CILINDROS DE RUEDA

NÚMERO DE PARTE	NÚMERO RAYBESTOS	MEDIDA	APLICACIÓN	FOTO PÁGINA
LC-37782	WC-36076	20.6 mm 13/16"	Ford Tras. Izq. Fairmont, Fairmont Vagoneta 78-83, Mustang 82-84, VAM Gremlin 77-83, Javelin 70-73, Pacer 79, Rally 70-73, 77-83	591
LC-37783	WC-36077	20.6 mm 13/16"	Ford Tras. Der. Fairmont, Fairmont Vagoneta 78-83, Mustang 82-84, VAM Gremlin 77-83, Javelin 70-73, Pacer 79, Rally 70-73, 77-83	591
LC-37786	WC37786	22.2 mm 7/8"	Suzuki Tras. Izq. Der. Pick Up Samurai 86-95 USA	591
LC-37787	WC-37787	17.4 mm 11/16"	Chrys. Tras Izq Der Neon 00-05, Ford Escort 94-01, Escort Vagoneta 94-99	591
LC-37799	WC37799	17.4 mm 11/16"	Chevrolet Tras. Izq. Der. LeMans 88-93, Isuzu Optima 88-91 USA	591
LC-37839	WC37839	17.4 mm 11/16"	Mazda Tras. Izq. Mazda Truck MPV 89-90, MPV Van Wagon 89-90, Pickup 87-93. USA	591
LC-37840	WC37840	17.4 mm 11/16"	Mazda Tras. Der. Mazda Truck MPV 89-90, MPV Van Wagon 89-90, Pickup 87-93. USA	591
LC-37841	WC37841	22.2 mm 7/8"	Chrysler Town and Country Van 97-07, Voyager 00-03, Dodge Caravan 96-07, Plymouth Voyager 97-00 Tras Izq Der USA	591
LC-37842	WC37842	23.8 mm 15/16"	Toyota Tras. Izq. Der. 4-Runner 88-89 y 92-00, T100 Pick-up 93-98. USA	591
LC-37844	WC37844	19.0 mm 3/4"	Chrysler Tras. Izq. Der. Dodge Dakota 87-93. USA	591
LC-37846	WC-37846	19.0 mm 3/4"	Honda Tras. Izq. Civic 97-01	591
LC-37847	WC-37847	19.0 mm 3/4"	Honda Tras. Der. Civic 97-01	592
LC-37848	WC37848	19.0 mm 3/4"	Toyota Tacoma 95-04, Toyota 4 Runner 87-03, Toyota Pickup 87-95, Toyota T100 93-94 Tras Izq Der USA	592
LC-37849	WC37849	19.0 mm 3/4"	Toyota Tacoma 95-04 Tras Izq Der USA	592
LC-37850	WC37850	15.8 mm 5/8"	Geo Tras. Izq. Der. Geo Metro 89-97, Suzuki Swift 89-98. USA	592
LC-37851	WC37851	15.8 mm 5/8"	Mitsubishi Eclipse 94 Tras Izq Der USA	592
LC-37852	WC-37852	23.8 mm 15/16"	Chevrolet Tras. Der. Geo Traker 93-95.	592
LC-37853	WC-37853	23.8 mm 15/16"	Chevrolet Tras. Izq. Geo Traker 93-95.	592
LC-37854	WC-37854	22.2 mm 7/8"	Chevrolet Tras. Izq. Der. Blazer 95-97, S-10 Pick Up 03-04.	592
LC-37855	WC-37855	23.8 mm 15/16"	Chevrolet Tras. Izq. Der. Boneville 94-95, Cadillac De Ville concours 94-96, Cadillac De Ville 91-93, Oldsmobile 88' 92, 94-95, Silhouette 92, 94-95, Lumina Apv 95-96, Venture Apv 97-04.	592
LC-37856	WC-37856	22.2 mm 7/8"	Ford Tras. Izq. Der. Aeroestar 91-93, Explorer 91-94.	592
LC-37857	WC-37857	25.4 mm 1"	Ford Tras. Izq. Der. Sable 94-95. Nissan Quest 97-98.	592
LC-37858	WC-37858	20.6 mm 13/16"	Honda Tras. Izq. Acord L4 96-02, Accord V6 98 00	592
LC-37859	WC-37859	20.6 mm 13/16"	Honda Tras. Der. Acord L4 96-02, Accord V6 98 00	592
LC-37860	WC37860	19.0 mm 3/4"	Toyota 4 Runner 96-00, Toyota Landcruiser 81-95, Toyota T100 93-98, Toyota Tundra 00-06 Tras Izq Der USA	592
LC-37862	WC-37862	20.6 mm 13/16"	Chrysler Tras. Izq. Der. Jeep Cherokee 94-01, Jeep Wrangler 93-99.	592
LC-37863	WC-37863	19.0 mm 3/4"	Chrysler Tras. Izq. Der. Grand Voyager 4X4 95, Town & Country 95-96, Voyager 94-95 4X4 sin ABS USA.	592
LC-37864	WC-37864	15.8 mm 5/8"	Chrysler Tras. Izq. Der. Spirit 90-95.	593
LC-37865	WC37865	19.0 mm 3/4"	Honda Civic 90-91 Tras Izq Der USA	593
LC-37867	WC37867	17.4 mm 11/16"	Chevrolet Astro Mini Van 85-86, Safari Mini Van 85-86 Tras Izq Der USA	593
LC-37869	WC-37869	15.8 mm 5/8"	Nissan Tras. Izq. Der. Sentra 1.6 Lts 92 y 96-00, Tsuru GSR 2000 93-96 Sentra 2.0 Lts. 96-01.	593
LC-37870	WC-37870	20.6 mm 13/16"	Nissan Tras. Izq. Der. Trk. D21 90-92, Trk. Pathfinder 89-92 USA	593
LC-37871	WC-37871	20.6 mm 13/16"	Nissan Tras. Izq. Der. Pathfinder Xe 97-98.	593
LC-37872	WC-37872	22.2 mm 7/8"	Nissan Tras. Izq. Der. Pick Up D-21 92-01, Pick Up 250 94-96.	593
LC-37944	WC37944	25.4 mm 1"	Chevrolet Tras. Der. Chev. 40, 400, 4000 Series 89-92, GMC 40 Series, 89-92 GMC 400, 4000, 4500 Series 88-90, Isuzu. 88-94 USA	593

CILINDROS DE RUEDA



Lusac



Raybestos
The best in brakes

TABLA DE APLICACIONES POR LÍNEA DE PRODUCTO

CILINDROS DE RUEDA				
NÚMERO DE PARTE	NÚMERO RAYBESTOS	MEDIDA	APLICACIÓN	FOTO PÁGINA
LC-37945	WC37945	25.4 mm 1"	Chevrolet Tras. Der. Chev. 40, 400, 4000 Series 89-92, GMC 40 Series, 89-92 GMC 400, 4000, 4500 Series 88-90, Isuzu 88-94 USA	593
LC-37946	WC37946	25.4 mm 1"	Chevrolet Tras. Izq. Chev. 40, 400, 4000 Series 89-92, GMC 40 Series 88-90, GMC 400, 4000, 4500 Series 89-92, Isuzu 88-94. USA	593
LC-37961	WC37961	17.4 mm 11/16"	Geo Metro 92-96 Tras Der USA, Suzuki Aerio 06-07 Nacional, Suzuki Esteem 95-02; Suzuki Swift 89-94 USA	593
LC-37962	WC37962	17.4 mm 11/16"	Geo Metro 92-96 Tras Izq USA, Suzuki Aerio 06-07 Nacional, Suzuki Esteem 95-02; Suzuki Swift 89-94 USA	593
LC-37963	WC37963	22.2 mm 7/8"	Hyundai Tras. Der. Hyundai Excel 90-94, Hyundai Scoupe 92-95, Mitsubishi Precic 91-93. USA	593
LC-37967	WC-37967	19.0 mm 3/4"	Chevrolet Tras. Izq. Der. S-10 Pick Up 95-02.	593
LC-37968	WC37968	19.0 mm 3/4"	Hyundai Excel 89, Mitsubishi Precic 89 Tras Izq Der USA	593
LC-37969	WC37969	19.0 mm 3/4"	Chrysler Dodge 2000 GTX 89-92, Eagle 2000 GTX (Canada)90-93, Mitsubishi Galant 89-93, Mitsubishi Mirage 93-98 Tras Izq Der USA	593
LC-37970	WC-37970	19.0 mm 3/4"	Chrysler Tras. Izq. Der. Dodge Breeze 96, Stratus 95-00.	594
LC-37973	WC-37973	20.6 mm 13/16"	Chevrolet Tras. Izq. Der. Firebird Transam 94-97	594
LC-37975	WC-37975	22.2 mm 7/8"	Chevrolet Tras. Der. Geo Tracker 98	594
LC-37976	WC-37976	22.2 mm 7/8"	Chevrolet Tras. Izq. Geo Tracker 98.	594
LC-37982	WC37982	17.4 mm 11/16"	Subaru Tras. Izq. Der. Subaru Impreza 93-96, Subaru Legacy Sedan 95-98 USA	594
LC-37984	WC-37984	17.4 mm 11/16"	Chrysler Tras. Izq. Der. Grand Voyager 91-00 2X4 con ABS USA.	594
LC-37985	WC-37985	23.8 mm 15/16"	Chevrolet Tras. Izq. Der. Express 1500, Express Cargo Van 1500 98-02, Express 2500 y Express Cargo Van 2500 99-02, G15 98-02, Chrysler Ram 1500 94-01, Ram 2500 94-01, Ram Quad Cab 2500 98-01, Ram Runner V-10 96-97	594
LC-37986	WC-37986	19.0 mm 3/4"	Seat Tras. Izq. Der. Cordoba 01-04, Volkswagen. Golf A3 CL, GL, 93-99, Golf A3 GLS 93-99, Golf Cabrio A3 96-99, Jetta A3 CL, GL 93-99, Jetta GLS A3 93-98, Polo 03-08	594
LC-37995	WC37995	20.6 mm 13/16"	Hyundai Tras. Der. Hyundai Excel 90-94, Scoupe 93-95, Mitsubishi Precic 92-93 USA	594
LC-37996	WC37996	20.6 mm 13/16"	Hyundai Tras. Izq. Hyundai Excel 90-94, Scoupe 93-95, Mitsubishi Precic 92-93 USA	594
LC-37997	WC-37997	22.2 mm 7/8"	Ford Tras. Izq. Der. Contour 96-00, Mystique 95-00.	594
LC-37999	WC-37999	23.8 mm 15/16"	Ford Tras. Izq. Der. Aeroestar 94-95	594
LC-40416	WC-36050	28.5 mm 1-1/8"	Chrysler Del. Izq. Dart 70, Super Bee 70, Valiant Duster 71-72, D-300 72-74.	594
LC-40417	WC-36051	28.5 mm 1-1/8"	Chrysler Del. Der. Dart 70, Super Bee 70, Valiant Duster 71-72, D-300 72-74.	594
LC-40823	WC-36100	26.9 mm 1-1/16"	Ford Del. Izq. Maverick 70.	594
LC-40824	WC-36101	26.9 mm 1-1/16"	Ford Del. Der. Maverick 70.	594
LC-40951	WC-36017	28.5 mm 1-1/8"	Ford Del. Izq. Maverick 71-75, F-350 87-89, VAM Classic 70-73, Javelin 70, Rally 70-73, Jeep CJ-5 73-77	595
LC-40952	WC-36018	28.5 mm 1-1/8"	Ford Del. Der. Maverick 71-75, F-350 87-89, VAM Classic 70-73, Javelin 70, Rally 70-73, Jeep CJ-5 73-77.	595
LC-40965	WC-37231	25.4 mm 1"	VAM Del. Izq. Der. Willys Jeep 64-69, Jeep CJ-5 70-72.	595
LC-41718	WC-37083	26.9 mm 1-1/16"	Ford Del. Izq. Camioneta. F - 350 70-71. Chevelle 73-75.	595
LC-41719	WC-37084	26.9 mm 1-1/16"	Ford Del. Izq. Der. Camioneta. F - 350 70-71, Chevelle 73-75.	595
LC-42190	WC-37035	26.9 mm 1-1/16"	Ford Del. Izq. Camion F-500, B-500 70-71 USA.	595
LC-42191	WC-37036	26.9 mm 1-1/16"	Ford Del. Der. Camion B-500, F-500 70-71. USA.	595
LC-43375	WC-37033	28.5 mm 1-1/8"	Chrysler Del. Izq. D-500 70-71, D-600 75-76, Ford B-600 74-88, F-600 70-82.	595
LC-43376	WC-37034	28.5 mm 1-1/8"	Chrysler Del. Der. D-500 70-71, D-600 75-76, Ford B-600 74-88, F-600 70-82.	595

CILINDROS DE RUEDA



TABLA DE APLICACIONES POR LÍNEA DE PRODUCTO

CILINDROS DE RUEDA				
NÚMERO DE PARTE	NÚMERO RAYBESTOS	MEDIDA	APLICACIÓN	FOTO PÁGINA
LC-45873	WC-37024	22.2 mm 7/8"	Chevrolet Tras. Izq. Der. Chevelle 71-75, Chevelle Malibu 71-75, Chevy Nova 73-76	595
LC-45960	WC-37125	30.1 mm 1-3/16"	VAM Del. Izq. Javelin 68-70.	595
LC-45961	WC-37126	30.1 mm 1-3/16"	VAM Del Der. Javelin 68-70.	595
LC-45995	WC-37019	28.5 mm 1-1/8"	Chevrolet Del Izq. Chevelle Malibu 70, Opel 70-72	595
LC-45996	WC-37020	28.5 mm 1-1/8"	Chevrolet Del Der. Chevelle Malibu 70, Opel 70-72	595
LC-45997	WC-37025	28.5 mm 1-1/8"	Chev. Del. Izq. C-10 70-71.	595
LC-45998	WC-37026	28.5 mm 1-1/8"	Chev. Del. Der. C-10 70-71.	595
LC-45999	WC-37021	23.8 mm 15/16"	Chevrolet Tras. Izq. Der. Chevelle 70, Chevelle Malibu 70, Chevy Nova 77-78, Opel 70-72	596
LC-46251	WC-37014	28.5 mm 1-1/8"	VAM Del. Izq. American 71-73. Classic 70-73, Gremlin 74-76, Rally 70-73.	596
LC-46252	WC-37015	28.5 mm 1-1/8"	VAM Del. Der. American 71-73. Classic 70-73, Gremlin 74-76, Rally 70-73.	596
LC-48418	WC-37089	20.6 mm 13/16"	VAM Tras. Izq. Willys Jeep 64-69, CJ-5 70-72, DJ-5 70-73.	596
LC-48419	WC-37090	20.6 mm 13/16"	VAM Tras. Der. Willys Jeep 64-69, CJ-5 70-72, DJ-5 70-73.	596
LC-49232	WC-31139	27.7 mm 1-3/32"	Ford Del Izq. 60-69.	596
LC-49233	WC-31140	27.7 mm 1-3/32"	Ford Del. Der. 60-69.	596
LC-49331	WC-37108	21.4 mm 27/32"	Ford Tras. Izq. Der. Maverick 70.	596
LC-49680	WC-37040	28.5 mm 1-1/8"	Chevrolet Tras. Izq. Camioneta. C-20 71-76 USA.	596
LC-49681	WC-37039	28.5 mm 1-1/8"	Chevrolet Tras. Der. Camioneta. C-20 71-76 USA.	596
LC-50014	WC-37016	23.8 mm 15/16"	VAM Tras. Izq. Der. American 71-73, Classic 70, Rally 70-75, Gremlin 77-78, Javelin 68-70	596
LC-50371	WC-35073	27.7 mm 1-3/32"	VAM Tras. Izq. American 65-69. USA	596
LC-50372	WC-35074	27.7 mm 1-3/32"	VAM Tras. Der. American 65-69. USA	596
LC-51081	WC-37048	23.8 mm 15/16"	Chevrolet Tras. Izq. Der. Caprice 78-82, Impala 71-75, Blazer Nevada 91, C-10 74-78, C-15 82-87, G-20 95, VAM Wagonner 77-83.	596
LC-51087	WC-37079	30.1 mm 1-3/16"	Chevrolet Del. Der. Impala 70	596
LC-51088	WC-37080	25.4 mm 1"	Chevrolet Tras. Izq. Der. Impala 70, C-10 74-78, C-15 82-87, C-20, 25 79-87, C-30, 35 74-75, Suburban 87.	596
LC-51135	WC-37042	38.1 mm 1-1/2"	Chevrolet Inf. Tras. Izq. Der. Camion C-50, C-60 64-65.	597
LC-51136	WC-37078	30.1 mm 1-3/16"	Chevrolet Del. Izq. Impala 70	597
LC-55674	WC-37099	38.1 mm 1-1/2"	Chrysler Sup. Tras. Izq. Der. Dodge Camion D- 500, D-600 60-68.	597
LC-55675	WC-37094	38.1 mm 1-1/2"	Ford Tras. Der. Camion F-500, F-600 66-69	597
LC-55890	WC-37118	27.7 mm 1-3/32"	Ford Del. Izq. B-600, F-600 70-76 y 80-85,	597
LC-55891	WC-37119	27.7 mm 1-3/32"	Ford Del. Der. B-600, F-600 70-76 y 80-85,	597
LC-56407W	WC-37117	20.6 mm 13/16"	Chevrolet Tras. Izq. Der. Camioneta G-10 65-69	597
LC-57146	WC-37132	25.4 mm 1"	Ford Tras. Izq. F-200 86, F-350 70-72, 84-92, VAM. Jeep DJ-5 70-73, Wagoneer J-164 70-73.	597
LC-57147	WC-37133	25.4 mm 1"	Ford Tras. Der. F-200 86, F-350 70-72, 84-92, VAM. Jeep DJ-5 70-73, Wagoneer J-164 70-73.	597
LC-57150	WC-37153	41.3 mm 1-5/8"	Chevrolet Tras. Izq. C-50 70-72, C-60, C-70, 1968-69 Camiones, Ford F-600 69, F-700 66-67 (Superior) Camiones	597
LC-57151	WC-37154	41.3 mm 1-5/8"	Chevrolet Tras. Der. C-50 70-72, C-60, C-70, 1968-69 Camiones, Ford F-600 69-72, F-700 66-67 (Superior) Camiones	597
LC-57152	WC-37155	41.3 mm 1-5/8"	Chevrolet Inferior Camiones Tras. Izq. C-50 70-72, Ford F-600 69.	597
LC-57153	WC-37156	41.3 mm 1-5/8"	Chevrolet Inferior Camiones Tras. Der. C-50 70-72, Ford F-600 69.	597
LC-57850	WC-37158	38.1 mm 1-1/2"	Chevrolet Inf. Tras. Izq. Der. Camion C-30 70, C-40 70, C-50 70-72.	597
LC-57851	WC-37157	38.1 mm 1-1/2"	Chevrolet Sup. Tras. Izq. Der. Camion C-30, 35 70, C-40 70, C-50 70-72.	597

CILINDROS DE RUEDA



Lusac



Raybestos
The best in brakes

TABLA DE APLICACIONES POR LÍNEA DE PRODUCTO

CILINDROS DE RUEDA				
NÚMERO DE PARTE	NÚMERO RAYBESTOS	MEDIDA	APLICACIÓN	FOTO PÁGINA
LC-59240	WC-17509	23.8 mm 15/16"	Chrysler Tras. Izq. Dart 71-72, Super Bee 70, Valiant Duster 71-72, Dina 3000, 3200 75-80, Ford Econoline E-150, Club Wagon E-150 95-96. F-100 70-71, F-150 87-99, Galaxie 70-72. P-350 Microbus 72-76, VAM American 74-76 y 83. Classic 74-76. Jeep CJ-5 73-75, Wagoneer J-164 70-73 y 74-76	597
LC-59241	WC-17510	23.8 mm 15/16"	Chrysler Tras. Der. Dart 71-72, Super Bee 70, Valiant Duster 71-72, Dina 3000, 3200 75-80, Ford Econoline E-150, Club Wagon E-150 95-96. F-100 70-71, F-150 87-99, Galaxie 70-72. P-350 Microbus 72-76, VAM American 74-76 y 83. Classic 74-76. Jeep CJ-5 73-75, Wagoneer J-164 70-73 y 74-76	598
LC-71202	WC-37103	25.4 mm 1"	Chrysler Del. Izq. Dodge Dart 70-72. Valiant Duster 70-72.	598
LC-71203	WC-37102	25.4 mm 1"	Chrysler Del. Der. Dodge Dart 70-72. Duster 70-72.	598
LC-71210	WC-37112	28.5 mm 1-1/8"	Chevrolet Del. Izq. Chevelle 70-72.	598
LC-71211	WC-37113	28.5 mm 1-1/8"	Chevrolet Del. Der. Chevelle 70-72.	598
LC-71214	WC-36017	28.5 mm 1-1/8"	Ford Del. Izq. P-350 Microbus 72-76.	598
LC-71215	WC-36018	28.5 mm 1-1/8"	Ford Del. Der. P-350 Microbus 72-76.	598
LC-71216	WC-37232	20.6 mm 13/16"	Ford Tras. Izq. Camioneta. E-200, 250 69-74 USA.	598
LC-71217	WC-37233	20.6 mm 13/16"	Ford Tras. Der. Camioneta. E-200, 250 69-74 USA.	598
LC-71221	WC-37181	38.1 mm 1-1/2"	Chevrolet Inf. Tras. Izq. Der. Camion 40 70.	598
LC-71222	WC-37160	38.1 mm 1-1/2"	Chevrolet Sup. Tras. Izq. Der. Camion C-50 70-72.	598
LC-71238	WC-37152	41.3 mm 1-5/8"	Ford Tras. Izq. Der. B-600, F-600 70 - 88,	598
LC-71940	WC-37227	28.5 mm 1-1/8"	Ford Del. Izq. Camion B-600, F-600 74-79.	598
LC-71941	WC-37228	28.5 mm 1-1/8"	Ford Del. Der. Camion B-600, F-600 74-79.	598
LC-72257	WC-22916	28.5 mm 1-1/8"	Ford Del. Izq. Galaxie 70-72.	598
LC-72258	WC-22917	28.5 mm 1-1/8"	Ford Del. Der. Galaxie 70-72.	598
LC-73500	WC-37252	28.5 mm 1-1/8"	Ford Del. Izq. Camion B-600, F-600 70-88.	599
LC-73501	WC-37253	28.5 mm 1-1/8"	Ford Del. Der. Camion B-600, F-600 70-88.	599
LC-73608	WC-37172	30.1 mm 1-3/16"	Chrysler Del. Der. Dodge Monaco 70-72, D-100 72-73.	599
LC-73609	WC-37171	30.1 mm 1-3/16"	Chrysler Del. Izq. Dodge Monaco 70-72, D-100 72-73.	599
LC-73620	WC-37267	23.8 mm 15/16"	Ford Tras. Der. F-150 80-83	599
LC-73621	WC-37268	23.8 mm 15/16"	Ford Tras. Izq. F-150 80-83	599
LC-73622	WC-37281	25.4 mm 1"	Ford Tras. Izq. Camioneta. Ranchero 73-74. USA.	599
LC-73623	WC-37282	25.4 mm 1"	Ford Tras. Der. Camioneta. Ranchero 73-74. USA.	599
LC-73626	WC-37286	28.5 mm 1-1/8"	Chrysler Del. Izq. Dodge Dart 73-76, Valiant Duster 73-76.	599
LC-73627	WC-37287	28.5 mm 1-1/8"	Chrysler Del. Der. Dodge Dart 73-76, Valiant Duster 73-76.	599
LC-78314	WC-36105	21.4 mm 27/32"	Ford Tras. Izq. Maverick 71-73.	599
LC-78315	WC-36106	21.4 mm 27/32"	Ford Tras. Der. Maverick 71-73.	599
LC-78472	WC-15317	44.4 mm 1-3/4"	Ford Camion 800 53-55 Del y Tas	599
LC-78743	WC-37149	38.1 mm 1-1/2"	Ford Tras. Izq. Der. B-600, F-600 70-85.	599
LC-78744	WC-37240	38.1 mm 1-1/2"	Chevrolet Tras. Izq. Camioneta. C-30,35 71-72. C-40 71-72 Camion C-50 73-88, C-65 79-85.	599
LC-78745	WC-37241	38.1 mm 1-1/2"	Chevrolet Tras. Der. Camioneta. C-30,35 71-72. C-40 71-72 Camion C-50 73-88, C-65 79-85	599
LC-78974	WC-9025	25.4 mm 1"	Chrysler Tras. Izq. Durango 99-02, D-300 72-80, D-350 Microbus 81-87, M-300 78 y 80, Ram Van 1500 98-03, Ram 1500 02, Ram Wagon 1500 98-03, Ram Van 2500 98-02, Ram Wagon 2500 98-02, W-250 (4 X 4) 89-93, Ford Econoline Van E-150 97-08, Club Wagon V6 E-150 97-03, Club Wagon V8 E-250 97-04, Econoline Wagon Diesel 01 y 03, Club Wagon V8 E-250 Chateau 95-96 y 98-00, Club Wagon E-350 97-98. F-150 84-86 y 97-04. F-200 86 y 90-91, F-250 92 y 94, F-250 y Super Duty 98-02, Lobo 97-99 y Lobo 250 99	600

CILINDROS DE RUEDA



TABLA DE APLICACIONES POR LÍNEA DE PRODUCTO

CILINDROS DE RUEDA				
NÚMERO DE PARTE	NÚMERO. RAYBESTOS	MEDIDA	APLICACIÓN	FOTO PÁGINA
LC-78975	WC-9026	25.4 mm 1"	Chrysler Tras. Der. Durango 99-02, D-300 72-80, D-350 Microbus 81-87, M-300 78 y 80, Ram Van 1500 98-03, Ram 1500 02, Ram Wagon 1500 98-03, Ram Van 2500 98-02, Ram Wagon 2500 98-02, W-250 (4 X 4) 89-93, Ford Econoline Van E-150 97-08, Club Wagon V6 E-150 97-03, Club Wagon V8 E-250 97-04, Econoline Wagon Diesel 01 y 03, Club Wagon V8 E-250 Chateau 95-96 y 98-00, Club Wagon E-350 97-98. F-150 84-86 y 97-04. F-200 86 y 90-91, F-250 92 y 94, F-250 y Super Duty 98-02. Lobo 97-99 y Lobo 250 99	600
LC-79767	WC-37290	26.9 mm 1-1/16"	Chevrolet Tras. Izq. Der C-30, C-35 76-78, 84-87, 90, 92-95, G-30 Express, Cargo Van 3500 97/01-02, G-30 97, 01-02., Chrysler . Ram 3500 94-01, Ram Van 3500 98-99, Ram Wagon 3500 98-99, Ram 4000 95-02. Ram Srt-10 05-06	600
LC-079768	WC-37337	30.1 mm 1-3/16"	Chevrolet Tras. Izq. Der. C-30, C-35 79-95, C-35, C-3500, C-3500 Hd 96-00, Microbus 88-00, Panel P-30 82-03.	600
LC-79794	WC-37334	26.9 mm 1-1/16"	Chevrolet.Del. Der C-30,35 82-83, 88-89., Ford . Camioneta 82-83, 88-89.	600
LC-79795	WC-37333	26.9 mm 1-1/16"	Chevrolet.Del Izq C-30,35 82-83, 88-89., Ford . Camioneta 82-83, 88-89.	600
LC-79985	WC-37029	22.2 mm 7/8"	Ford Tras. Izq. Der. Mustang 74-78	600
LC-80186	WC-37648	20.6 mm 13/16"	Ford Tras. Izq. Camioneta. E-100 74. USA.	600
LC-80187	WC-37658	20.6 mm 13/16"	Ford Tras. Der. Camioneta. E-100 74. USA.	600
LC-80918	WC-37269	26.9 mm 1-1/16"	Chrysler Tras. Izq. Dodge Dart,Duster,Valiant. 73. USA.	600
LC-80919	WC-37270	26.9 mm 1-1/16"	Chrysler Tras. Der. Dodge Dart,Duster,Valiant. 73. USA.	600
LC-86000	WC-37291	28.5 mm 1-1/8"	Chevrolet Tras. Izq. Der. Camioneta. C-30,35 74-78.	600
LC-90549	WC-37109	22.2 mm 7/8"	VW Del. Izq. Der. Safari 71-77, Sedan 70-94	600
LC-90550	WC-37110	19.0 mm 3/4"	VW Tras. Izq. Der. Sedan 70-72	600
LC-93356	WC-37111	17.4 mm 11/16"	VW Tras. Izq. Der. Sedan 73-04	600
LC-96387	WC-37349	23.8 mm 15/16"	VW Tras. Izq. Der. Combi - Panel 70-01, Hormiga 76-78	600
LC-96399	WC-37332	17.4 mm 11/16"	VW Tras. Izq. Der. Atlantic 81-87, Caribe 78-87, Caribe Gti 83-86, Corsar 83-88, Corsar Variant 86-88, Derby 95-97. Golf A-2 C, CL, GL. Jetta A-2 87-92.	601
LC-96402	WC-37345	14.2 mm 9/16"	VW Tras. Izq. Der. Caribe 77-79.	601
LC-96613	WC-37407	20.6 mm 13/16"	Nissan Tras. Izq. Der. Datsun 73-83, Sakura 82	601
LC-99284	WC-37342	22.2 mm 7/8"	Ford Tras. Izq. Der. Gran Marquis 82	601
LC-101604	WC-37400	19.0 mm 3/4"	Ford Tras. Izq. Der. Cougar 85-92, Mustang 83-84. Ranger 04-07.	601
LC-101610	WC-37343	23.8 mm 15/16"	Ford Tras. Izq. Der. Grand Marquis 83-84, LTD 79-80, Crown Victoria 81.	601
LC-103223	WC-37593	27.7 mm 1-3/32"	Ford Del. Izq. Camion B-600, F-600 80-85.	601
LC-103224	WC-37594	27.7 mm 1-3/32"	Ford Del. Der. Camion B-600, F-600 80-85.	601
LC-104384	WC-37531	17.4 mm 11/16"	Chevrolet Tras. Izq. Der. Celebrity 83-89, Century 83-89, 92-93, Citation 83-86, Cutlass y Cutlass Eurosport 87-89	601
LC-106006	WC-37236	22.2 mm 7/8"	Chrysler Tras. Izq. Der. Dodge D-100 72-73.	601
LC-106315	WC-37235	23.8 mm 15/16"	Chrysler Tras. Izq. Der. Cordoba 80-82, Coronet 71-74, Dart 70-82, Le Baron 78-82, Magnum 81-82. Monaco 70-77, Super Bee 70, Valiant Duster 70-76, D-100 70, y 73-80, D-150 81-93. D-250 86-93, W-150 85-87, W-250 4 X 4 89-93, Valiant Volare 77-81, Ram Charger 85-01. Ram Van 1500, Ram Wagon 94-97. Ram Van 2500, Ram Wagon 2500 96-97.	601
LC-106922	WC-37537	26.9 mm 1-1/16"	Chrysler Tras. Izq. D-250 86-87. D-350, Microbus 88-90,	601
LC-106923	WC-37538	26.9 mm 1-1/16"	Chrysler Tras.D-250 86-87. Der. D-350, Microbus 88-90,	601
LC-107475	WC-37590	14.2 mm 9/16"	Chrysler Tras. Izq. Der. Dart E 89, Dart K 82- 88. Dart K Guayin 82-88. Magnum K 83-88. New Yorker 85-89, Phantom 87-89. Serie 600 K 84-85. Lebaron K 83-87, Volare K 82-88.	601
LC-107476	WC-37564	15.8 mm 5/8"	Chrysler Tras. Izq. Der. Dart K 82-88, Le Baron K 83-87, Magnum K 83-88, Neon 95-99, New Yorker 85-89, Phanton 87-89 , Serie 600 K 84-85, Shadow 89-94, Shadow Gts Turbo 89, Volare K 82-88.	601
LC-108106	WC-37592	22.2 mm 7/8"	Ford Tras. Der. Ghia 91-94, Topaz 84-94	601

CILINDROS DE RUEDA



Lusac



Raybestos
The best in brakes

TABLA DE APLICACIONES POR LÍNEA DE PRODUCTO

CILINDROS DE RUEDA				
NÚMERO DE PARTE	NÚMERO RAYBESTOS	MEDIDA	APLICACIÓN	FOTO PÁGINA
LC-108107	WC-37591	22.2 mm 7/8"	Ford Tras. Izq. Ghia 91-94, Topaz 84-94.	602
LC-109532	WC-37844	19.0 mm 3/4"	Chrysler Tras. Izq. Der. PT Cruiser 01-06, Dakota 96, Grand Voyager 91-95, Jeep Wrangler 96-06 Jeep Wrangler Sahara 97-06, Jeep Wrangler, Jeep Wrangler Rubicon 03-06, Town Contry 93-95, Voyager 94-95.	602
LC-110260	WC-37625	19.0 mm 3/4"	Chevrolet Tras. Izq. Der. Chevelle Malibu 79-81, Montecarlo 81-84	602
LC-112341	WC-37677	22.2 mm 7/8"	Chevrolet Tras. Izq. Der. Bonneville 96-99, Cavalier 97-02, Cutlass 93-96, Cutlass Eurosport 93-96, Century 94-96.	602
LC-112365	WC-37668	25.4 mm 1"	Ford Tras. Izq. Der. Taurus 88-91.	602
LC-113757	WC-37262	30.1 mm 1-3/16"	Ford Tras. Der. F-200 90-91, F-250 92-97, F-350 90-04, P-350 Microbus 89-96.	602
LC-113758	WC-37263	30.1 mm 1-3/16"	Ford Tras. Izq. F-200 90-91, F-250 92-97, F-350 90-04, P-350 Microbus 89-96.	602
LC-114197	WC-37869	15.8 mm 5/8"	Nissan Tras. Izq. Der. Sentra 1.6 Lts 92 y 96-00, Tsuru III GS 93-08, Tsuru GSR 2000 93-96 Sentra 2.0 Lts. 96-01.	602
LC-116224	WC-37785	30.1 mm 1-3/16"	Chevrolet Tras. Izq. Der. Blazer Nevada 92-94, C-15 94-99, C20, C25 95-01, Maxi Cab 91-93, Silverado 95-99, Sonora 00	602
LC-116263	WC-37784	28.5 mm 1-1/8"	Chevrolet Tras. Izq. Der. C-15 88-91, 94, 96-99, C20, C25 88-91, 96-01, Suburban 88.	602
LC-116359	WC-37781	25.4 mm 1"	Chevrolet Tras. Izq. Der. C-15 95, C-20, 25 92-95, Express 3500, Express Cargo Van 3500 98-00, G-30 98-00, Suburban 88-00	602
LC-0116366	WC-37778	17.4 mm 11/16"	Chevrolet Tras. Izq. Der. Cavalier 92-02, Cavalier Z24 91-96, Celebrity 87-89, Century 90-91, Cutlass 90-92, Cutlass Eurosport 91-92, Sunfire 97-02.	602
LC-116384	WC-37750	16.0 mm	Chevrolet Tras. Izq. Der. Cavalier 90-91, Cavalier Z24 91	602
LC-117345	N/D	19.0 mm 3/4"	Nissan Tras. Izq. Der. Datsun Sedan 81-84, Hikari 88-92, Tsuru I 84-87, Tsuru II 88-92,	602
LC-129564	WC-37857	25.4 mm 1"	Ford Tras. Izq. Der. Cougar 93-95. Thunderbird 89-96, Windstar 95-03.	602
LC-370018	N/D	17.8 mm 45/64"	Chrysler Tras. Izq. Der. Atos 01-08, Verna 04-06	602
LC-370027	WC-370027	19.0 mm 3/4"	Chrysler Tras. Izq. Der. Grand Voyager 96-00, Town Contry 97-00, Voyager 96-00.	603
LC-370031	WC-370031	19.0 mm 3/4"	Ford Tras. Izq. Der. Ranger 96-97. Tambor 10"	603
LC-370042	WC-370042	28.5 mm 1-1/8"	Ford Tras. Izq. Econoline Van E-250 97-99, Econoline Van E-350 99. Club Wagon V8 E-250 95-96, Club Wagon V8 E-350 XI 99-04, F-350 97-98.	603
LC-370043	WC-370043	28.5 mm 1-1/8"	Ford Tras. Der. Econoline Van E-250 97-99, Econoline Van E-350 99. Club Wagon V8 E-250 95-96, Club Wagon V8 E-350 XI 99-04, F-350 97-98.	603
LC-370050	WC370050	20.6 mm 13/16"	Honda Civic 88-89 Tras Izq Der USA	603
LC-370051	WC-370051	20.6 mm 13/16"	Chrysler Tras. Izq. Der. Grand Voyager 97-02. Voyager 97-06, Town Contry 97-04.	603
LC-370055	WC-370055	22.2 mm 7/8"	Chevrolet Tras. Izq. Der. Malibu LX 97-01, Malibu LS 97-05, Grand Am 99-05	603
LC-370061	WC-370061	20.6 mm 13/16"	Ford Tras. Izq. Der. Ranger Tambopr de 10" 98-07	603
LC-370073	WC370073	22.2 mm 7/8"	Chevrolet Tracker Tras Izq 99-07	603
LC-370074	WC370074	22.2 mm 7/8"	Chevrolet Tracker Tras Der 99-07	603
LC-370077	WC-370077	23.8 mm 15/16"	Chrysler Tras. Izq. Der. Ram Van 3500 00-02, Ram Wagon 3500 00-02.	603
LC-370080	WC370080	20.6 mm 13/16"	Ford Ford Contour 95-00 Nacional Cougar 99-02,, Mercury Mystique 95-00 Tras Izq Der USA	603
LC-370081	N/D	17.4 mm 11/16"	Chrysler Tras. Izq. Der. Neon 00-01.	603
LC-370083	WC-370083	25.4 mm 1"	Nissan Tras. Izq. Der. Quest (Minivan) 99-02	603
LC-370087	WC370087	22.2 mm 7/8"	Honda Odyssey Tras. Der. 00-01	603
LC-370088	WC370088	22.2 mm 7/8"	Honda Odyssey Tras. Izq. 00-01	603
LC-370091	WC-370091	22.2 mm 7/8"	Ford Tras. Izq. Explorer 01. USA	604
LC-370092	WC-370092	22.2 mm 7/8"	Ford Tras. Der. Explorer 01 USA	604
LC-370093	WC-370093	20.6 mm 13/16"	Ford Tras. Izq. Der. Focus LX, SE, ZTS , Wagon 00-01	604
LC-370094	WC-370094	23.8 mm 15/16"	Ford Tras. Izq. Der. Escape 01-06, Mariner 05-07.	604

CILINDROS DE RUEDA



TABLA DE APLICACIONES POR LÍNEA DE PRODUCTO

CILINDROS DE RUEDA				
NÚMERO DE PARTE	NÚMERO RAYBESTOS	MEDIDA	APLICACIÓN	FOTO PÁGINA
LC-370105	WC-370105	20.6 mm 13/16"	Chrysler Tras. Izq. Der. Jeep Liberty 02.	604
LC-370106	WC-370106	23.8 mm 15/16"	Nissan Altima 98-01 Tras Izq Der	604
LC-370111	WC-370111	22.2 mm 7/8"	Toyota Camry 02-06 Tras Izq	604
LC-370112	WC370112	19.0 mm 3/4"	Toyota Matrix ZR 4 cil 1.8L 03-08, Matrix ZR "S" 4 cil 1.8L 04-08, Tras Izq Der	604
LC-370117	WC-370117	22.2 mm 7/8"	GMC Aztek Tras Izq Der 01-05	604
LC-370121	WC-370121	22.2 mm 7/8"	Ford Focus LX, SE, ZTS, Wagon Tras. Izq. y Der. 05-06	604
LC-370123	WC-370123	20.6 mm 13/16"	Honda Tras. Der. Civic 03-06	604
LC-370127	WC-370127	20.6 mm 13/16"	Honda Tras. Izq. Civic 03-06	604
LC-370128	WC370128	25.4 mm 1"	Nissan Quest 01-03 Tras Izq Der	604
LC-370129	WC370129	20.6 mm 13/16"	Mitsubishi Outlander 03-04 Tras Izq Der	604
LC-370130	WC370130	22.2 mm 7/8"	Chevrolet Equinox; 05 Tras Izq Der	604
LC-370131	WC370131	19.0 mm 3/4"	Honda Civic Tras Der 02	604
LC-370132	WC370132	19.0 mm 3/4"	Honda Civic Tras Izq 02	605
LC-370133	WC370133	17.4 mm 11/16"	Chevrolet Cavalier Tras Izq Der 03-04	605
LC-370139	WC370139	19.0 mm 3/4"	Toyota Corolla Tras Der 03-08	605
LC-370142	WC370142	15.8 mm 5/8"	Nissan Sentra 01-02 Tras Izq Der	605
LC-370143	WC-370143	22.2 mm 7/8"	Toyota Tacoma 4X2 06-10 tras izq der	605
LC-370146	WC370146	19.0 mm 3/4"	Toyota Corolla Tras Izq 03-08	605
LC-370148	WC370148	23.8 mm 15/16"	Chevrolet Colorado 4 cil 2.9L 4X2 04-09, Colorado 5cil 4X2 04-09, Colorado 5cil 2.9L 4X4 05-09, GMC Canyon 07-09, Tras Izq Der	605
LC-370149	WC-370149	19.0 mm 3/4"	Honda: Civic 01-05 tras der	605
LC-370152	WC-370152	19.0 mm 3/4"	Honda: Civic 01-05 tras izq	605
LC-370153	WC-370153	22.2 mm 7/8"	Suzuki Gran Vitara 4 cil 2.3L 06-08, Gran Vitara V6 2.7L, Gran Vitara V6 2.7L 4X4 07-08, Tras Izq	605
LC-370154	WC370154	22.2 mm 7/8"	Nissan Pathfinder XE Tras. Izq. y Der. 02-04	605
LC-370155	WC370155	19.0 mm 3/4"	Mitsubishi Lancer 4 cil 2.0L 04-09, Lancer Ralliart 4 cil. 2.0L 05-06, Tras Izq Der	605
LC-370157	WC370157	15.8 mm 5/8"	Nissan Sentra 03-06 Tras Izq Der	605
LC-370158	WC370158	22.2 mm 7/8"	Nissan Frontier 4L Tras. Izq. y Der. 03	605
LC-370159	WC-370159	22.2 mm 7/8"	Suzuki Gran Vitara 4 cil 2.3L 06-08, Gran Vitara V6 2.7L, Gran Vitara V6 2.7L 4X4 07-08, Tras Der	605
LC-370174	WC-370174	22.2 mm 7/8"	Toyota Camry 02-06 Tras Der sustituye al WC 370122	605
LC-370176	WC-370176	20.6 mm 13/16"	Chrysler: PT Cruiser 04-09 Tras Izq Der	606
LC-370180	WC-370180	23.8 mm 15/16"	GMC: Sierra 1500 07-08, Sierra Classic 1500 07, Sierra Classic 1500HD 07, Silverado 1500 07-08, Silverado 1500HD 05-06, Silverado Classic 1500 07, Silverado Classic 1500HD 07 tras Izq Der	606
LC-370181	WC-370181	26.9 mm 1-1/16"	GMC Sierra 1500 07-08, Sierra Classic 1500 07, Silverado 1500 05-08 Tras Izq Der	606
LC-370182	WC-370182	19.0 mm 3/4"	Honda Civic 06-09, Honda Fit 09 Tras Izq Der	606
LC-370183	WC-370183	23.8 mm 15/16"	Toyota Tacoma 4X4 06-10 Tras Izq Der	606
LC-370185	WC-370185	19.0 mm 3/4"	Ford Ranger 01-06 Tras Izq Der	606
LC-370186	WC-370186	20.6 mm 13/16"	Chevrolet: HHR 06-09, HHR Panel 07-09 tras Izq Der	606
LC-370187	WC-370187	22.2 mm 7/8"	Chevrolet: Malibu 05-07 Tras Izq Der	606
LC-370189	WC370189	30.1 mm 1-3/16"	Chevrolet. Blazer 92-94, C10, C15 Pickup 88-99, 1988-1999, Tahoe 95-01, Yukon 92-00 Tras Izq Der USA	606
LC-370190	WC370190	23.8 mm 15/16"	Pontiac Bonneville 91-95, Deville/Concours 91-02, Fleetwood 91-92, LeSabre 92-95, Lumina APV Van 92-96, Oldsmobile 88 92-95, Oldsmobile Silhouette Van 92-04, Park Avenue 91-95 Tras Izq Der USA	606

CILINDROS DE RUEDA



Lusac



Raybestos
The best in brakes

TABLA DE APLICACIONES POR LÍNEA DE PRODUCTO

CILINDROS DE RUEDA				
NÚMERO DE PARTE	NÚMERO RAYBESTOS	MEDIDA	APLICACIÓN	FOTO PÁGINA
LC-370191	WC370191	20.6 mm 13/16"	Pontiac Bonneville 91-95, Deville/Concours 91-02, Fleetwood 91-92, LeSabre 92-95, Lumina APV Van 92-96, Oldsmobile 88 92-95, Oldsmobile Silhouette Van 92-04, Park Avenue 91-95 Tras Izq Der USA	606
LC-370195	WC-370195	19.0 mm 3/4"	Chrysler: Tras Izq Der PT Cruiser 01-04	606
LC-370301	N/D	19.0 mm 3/4"	VW Tras. Izq. Der. Pointer 98-02, Pointer City 00-02, Pointer Vagoneta 99-02.	606
LC-370361	N/D	19.0 mm 3/4"	Ford Tras. Izq. Der. Fiesta 98-02	606
LC-370366	N/D	19.0 mm 3/4"	Ford Tras. Izq. Der. Fiesta 98-02 y 03-08, Ka 01-07	606
LC-370382	N/D	22.0 mm	Chevrolet Tras. Der. Chevy Pick-Up 99-04	606
LC-370384	N/D	22.0 mm	Chevrolet Tras. Izq. Chevy Pick-Up 99-04	607
LC-3700900	N/D	19.0 mm 3/4"	Ford Tras. Izq. Der. Fiesta Ikon 01-03, Ford Tras. Izq. Der. Ka 1.6 Lts.01-07	607
LC-3700901	N/D	22.2 mm 7/8"	Ford Lobo Traz. Izq 00-02	607
LC-3700902	N/D	22.2 mm 7/8"	Ford Lobo Traz. Der 00-02	607
LC-3700904	N/D	22.2 mm 7/8"	Ford Courier Tras. Izq. Der. 01-06	607
LC-3700905	N/D	19.0 mm 3/4"	Chrysler Tras, Izq. Der. Stratus 95-00, con mamelon redondo para fijar en plato porta balatas	607
LC-3700908	N/D	19.0 mm 3/4"	Ford EcoSport Tras Izq Der 04-08	607
LC-3700912	N/D	22.2 mm 7/8"	Renault Kangoo 04-09 Tras Izq Der	607
LC-3700913	N/D	22.2 mm 7/8"	Peugeot Partner 1.6L 04-09 Tras Izq Der	607
LC-3700914	N/D	17.4 mm 11/16"	Pontiac Matiz Tra Izq Der 04-08	607
LC-3700915	N/D	22.2 mm 7/8"	Chevrolet Malibu 05-08 Tras Izq Der	607
LC-37009016	N/D	22.2 mm 7/8"	Hyundai H-100 03-05 Tras Der	607
LC-37009017	N/D	22.2 mm 7/8"	Hyundai H-100 03-05 Tras Izq	607
LC-41100B96	N/D	25.4 mm 1"	Nissan Tras. Sup Der. Pick-up 720 81-88. USA	607
LC-41101B96	N/D	25.4 mm 1"	Nissan Tras. Inf. Der. Pick-up 720 81-88. USA	607
LC-41102B96	N/D	25.4 mm 1"	Nissan Tras. Sup Izq. Pick-up 720 81-88. USA	607
LC-41103B96	N/D	25.4 mm 1"	Nissan Tras. Inf. Izq. Pick-up 720 81-88. USA	608
LC-4410000Q	N/D	17.4 mm 11/16"	Nissan Tras. Izq. Der. Platina 02-08	608
LC-441004Z0	WC370141	17.4 mm 11/16"	Nissan Tras Izq. Der. Sentra XE & GXE 1.8L 00-01	608
LC-441007Z0	WC370060	22.2 mm 7/8"	Nissan Pathfinder XE 99-01, XTerra 00-07, Frontier 03-04. Tras Izq.	608
LC-441007Z8	WC370060	22.2 mm 7/8"	Nissan Pathfinder XE 99-01, XTerra 00-07, Frontier 03-04. Tras Der.	608
LC-44100F40	44100F40	23.8 mm 15/16"	Nissan Tras. Izq. Der. Nissan Pick Up. D21 86-89, Nissan Trk. Pathfinder 93-95 USA	608
LC-44100U48	44100U48	22.2 mm 7/8"	Nissan Sedan 710 R. Tras.	608

CILINDROS DE RUEDA





CILINDROS DE RUEDA

LC-746 - LC-9336

FOTOS CILINDROS DE RUEDA





Lusac



Raybestos
The best in brakes

CILINDROS DE RUEDA

LC-9337 - LC-14205

 LC-9337 25.4 mm 1"	 LC-9344 31.7 mm 1-1/4"	 LC-9345 31.7 mm 1-1/4"	 LC-10028 20.6 mm 13/16"
 LC-10580 28.5 mm 1-1/8"	 LC-10581 28.5 mm 1-1/8"	 LC-10582 28.5 mm 1-1/8"	 LC-10583 28.5 mm 1-1/8"
 LC-10588 28.5 mm 1-1/8"	 LC-13368 26.9 mm 1-1/16"	 LC-13369 26.9 mm 1-1/16"	 LC-13387 25.4 mm 1"
 LC-13388 25.4 mm 1"	 LC-14068 25.4 mm 1"	 LC-14069 25.4 mm 1"	 LC-14205 28.5 mm 1-1/8"

FOTOS CILINDROS DE RUEDA



CILINDROS DE RUEDA

LC-14206 - LC-18180

FOTOS CILINDROS DE RUEDA





Lusac



Raybestos
The best in brakes

CILINDROS DE RUEDA

LC-18290 - LC-25463

 LC-18290 28.5 mm 1-1/8"	 LC-18291 28.5 mm 1-1/8"	 LC-18984 26.9 mm 1-1/16"	 LC-18985 26.9 mm 1-1/16"
 LC-19107 41.3 mm 1-5/8"	 LC-19109 44.4 mm 1-3/4"	 LC-19111 47.6 mm 1-7/8"	 LC-19746 38.1 mm 1-1/2"
 LC-20932 28.5 mm 1-1/8"	 LC-20933 28.5 mm 1-1/8"	 LC-24489 41.3 mm 1-5/8"	 LC-24954 28.5 mm 1-1/8"
 LC-24955 28.5 mm 1-1/8"	 LC-25459 41.3 mm 1-5/8"	 LC-25460 41.3 mm 1-5/8"	 LC-25463 41.3 mm 1-5/8"

FOTOS CILINDROS DE RUEDA



CILINDROS DE RUEDA

LC-25464 - LC-32555

FOTOS CILINDROS DE RUEDA

 LC-25464 41.3 mm 1-5/8"	 LC-26159 38.1 mm 1-1/2"	 LC-26172 44.4 mm 1-3/4"	 LC-27342 38.1 mm 1-1/2"
 LC-28661 38.1 mm 1-1/2"	 LC-28720 28.5 mm 1-1/8"	 LC-28721 28.5 mm 1-1/8"	 LC-28803 38.1 mm 1-1/2"
 LC-28804 23.0 mm 29/32"	 LC-28805 23.0 mm 29/32"	 LC-28850 38.1 mm 1-1/2"	 LC-32349 31.7 mm 1-1/4"
 LC-32350 31.7 mm 1-1/4"	 LC-32357 34.9 mm 1-3/8"	 LC-32358 34.9 mm 1-3/8"	 LC-32555 28.5 mm 1-1/8"



Lusac



Raybestos
The best in brakes

CILINDROS DE RUEDA

LC-32864 - LC-37208

 LC-32864 34.9 mm 1-3/8"	 LC-34072 23.8 mm 15/16"	 LC-34073 23.8 mm 15/16"	 LC-34177 25.4 mm 1"
 LC-34178 25.4 mm 1"	 LC-34333 28.5 mm 1-1/8"	 LC-34334 28.5 mm 1-1/8"	 LC-34401 22.2 mm 7/8"
 LC-34402 22.2 mm 7/8"	 LC-34474 28.5 mm 1-1/8"	 LC-34475 28.5 mm 1-1/8"	 LC-34876 20.6 mm 13/16"
 LC-35325 28.5 mm 1-1/8"	 LC-35326 28.5 mm 1-1/8"	 LC-37080 25.4 mm 1"	 LC-37208 19.0 mm 3/4"

FOTOS CILINDROS DE RUEDA



Lusac



Raybestos
The best in brakes

CILINDROS DE RUEDA

LC-37209 - LC-37377

FOTOS CILINDROS DE RUEDA



LC-37209
20.6 mm 13/16"



LC-37210
20.6 mm 13/16"



LC-37250
30.1 mm 1-3/16"



LC-37251
30.1 mm 1-3/16"



LC-37271
25.4 mm 1"



LC-37274
20.6 mm 13/16"



LC-37276
19.0 mm 3/4"



LC-37277
20.6 mm 13/16"

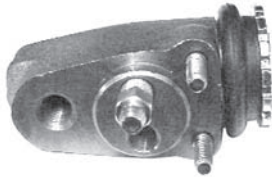

LC-37320
25.4 mm 1"



LC-37322
20.6 mm 13/16"

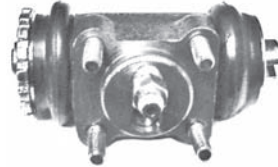

LC-37323
20.6 mm 13/16"



LC-37336
19.0 mm 3/4"



LC-37358
17.4 mm 11/16"



LC-37375
17.4 mm 11/16"



LC-37376
19.0 mm 3/4"



LC-37377
19.0 mm 3/4"







Lusac

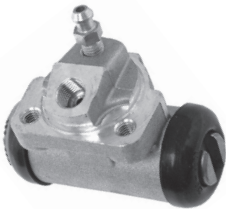

Raybestos
The best in brakes

CILINDROS DE RUEDA

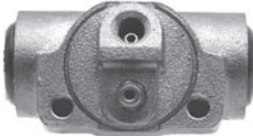
LC-37382 - LC-37548

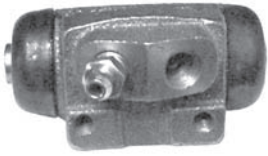
 <p>LC-37382 19.0 mm 3/4"</p>	 <p>LC-37404 19.0 mm 3/4"</p>	 <p>LC-37405 22.2 mm 7/8"</p>	 <p>LC-37407 20.6 mm 13/16"</p>
 <p>LC-37412 20.6 mm 13/16"</p>	 <p>LC-37420 22.2 mm 7/8"</p>	 <p>LC-37438 22.2 mm 7/8"</p>	 <p>LC-37459 23.8 mm 15/16"</p>
 <p>LC-37476 25.4 mm 1"</p>	 <p>LC-37499 15.8 mm 5/8"</p>	 <p>LC-37509 15.8 mm 5/8"</p>	 <p>LC-37529 20.6 mm 13/16"</p>
 <p>LC-37530 20.6 mm 13/16"</p>	 <p>LC-37535 16.0 mm</p>	 <p>LC-37539 25.4 mm 1"</p>	 <p>LC-37548 19.0 mm 3/4"</p>

FOTOS CILINDROS DE RUEDA



Lusac



Raybestos
The best in brakes

CILINDROS DE RUEDA

LC-37549 - LC-37604

FOTOS CILINDROS DE RUEDA



LC-37549
19.0 mm 3/4"



LC-37569
17.4 mm 11/16"



LC-37571
17.4 mm 11/16"



LC-37573
20.6 mm 13/16"

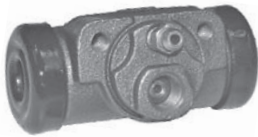

LC-37574
19.0 mm 3/4"



LC-37575
19.0 mm 3/4"

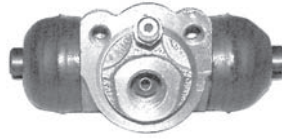

LC-37577
19.0 mm 3/4"

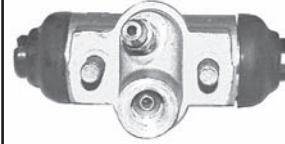

LC-37581
19.0 mm 3/4"

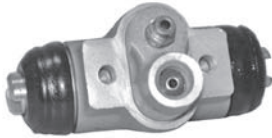

LC-37582
19.0 mm 3/4"

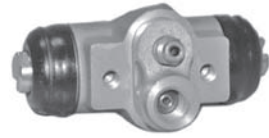

LC-37584
19.0 mm 3/4"

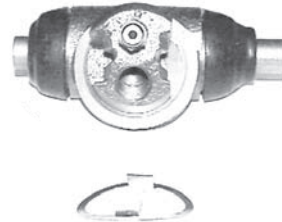

LC-37585
19.0 mm 3/4"



LC-37595
19.0 mm 3/4"



LC-37599
22.2 mm 7/8"



LC-37601
20.6 mm 13/16"

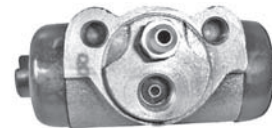

LC-37602
20.6 mm 13/16"



LC-37604
14.2 mm 9/16"







Lusac

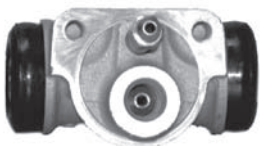

Raybestos
The best in brakes

CILINDROS DE RUEDA

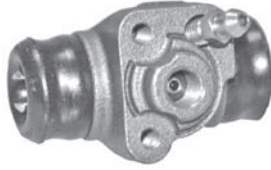
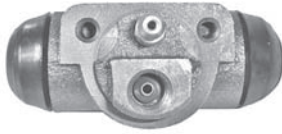
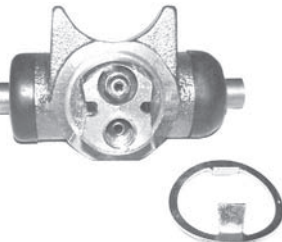
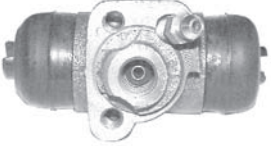
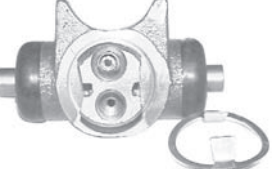
LC-37619 - LC-37663

 <p>LC-37619 19.0 mm 3/4"</p>	 <p>LC-37625 19.0 mm 3/4"</p>	 <p>LC-37626 15.8 mm 5/8"</p>	 <p>LC-37631 20.6 mm 13/16"</p>
 <p>LC-37634 19.0 mm 3/4"</p>	 <p>LC-37635 19.0 mm 3/4"</p>	 <p>LC-37636 19.0 mm 3/4"</p>	 <p>LC-37637 17.4 mm 11/16"</p>
 <p>LC-37640 20.6 mm 13/16"</p>	 <p>LC-37643 20.6 mm 13/16"</p>	 <p>LC-37644 22.2 mm 7/8"</p>	 <p>LC-37646 17.4 mm 11/16"</p>
 <p>LC-37647 19.0 mm 3/4"</p>	 <p>LC-37654 22.2 mm 7/8"</p>	 <p>LC-37660 22.2 mm 7/8"</p>	 <p>LC-37663 20.6 mm 13/16"</p>

FOTOS CILINDROS DE RUEDA



Lusac



Raybestos
The best in brakes

CILINDROS DE RUEDA

LC-37664 - LC-37709

FOTOS CILINDROS DE RUEDA



LC-37664
17.4 mm 11/16"



LC-37684
23.8 mm 15/16"

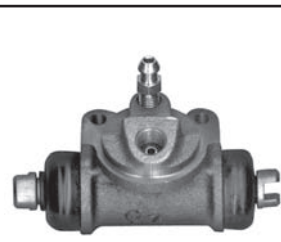

LC-37685
15.8 mm 5/8"

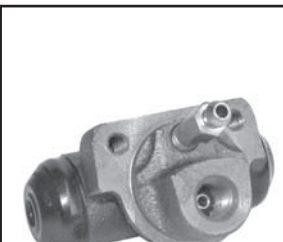

LC-37686
17.4 mm 11/16"

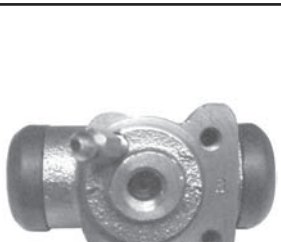

LC-37687
19.0 mm 3/4"

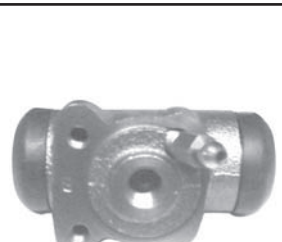

LC-37688
19.0 mm 3/4"



LC-37690
25.4 mm 1"

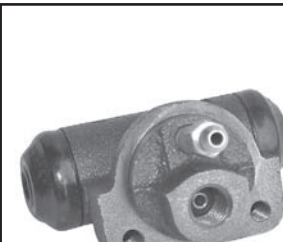

LC-37692
17.4 mm 11/16"

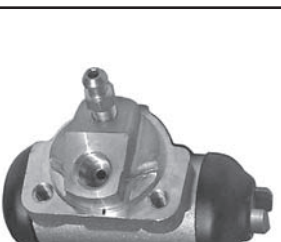

LC-37693
19.0 mm 3/4"

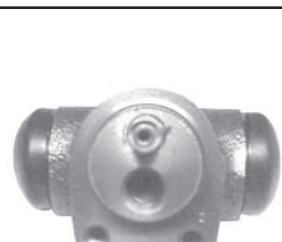

LC-37694
19.0 mm 3/4"



LC-37696
20.6 mm 13/16"



LC-37697
19.0 mm 3/4"



LC-37698
19.0 mm 3/4"

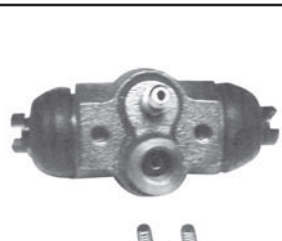

LC-37707
20.6 mm 13/16"

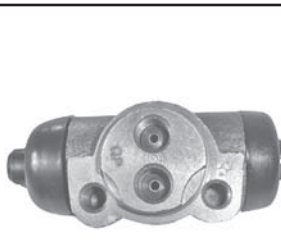

LC-37708
22.2 mm 7/8"

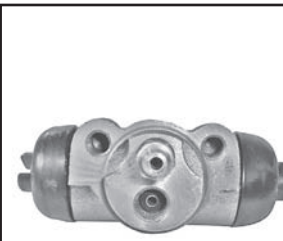

LC-37709
22.2 mm 7/8"



Lusac



Raybestos
The best in brakes

CILINDROS DE RUEDA

LC-37710 - LC-37846

 <p>LC-37710 23.8 mm 15/16"</p>	 <p>LC-37711 23.8 mm 15/16"</p>	 <p>LC-37751 19.0 mm 3/4"</p>	 <p>LC-37752 19.0 mm 3/4"</p>
 <p>LC-37779 19.0 mm 3/4"</p>	 <p>LC-37782 20.6 mm 13/16"</p>	 <p>LC-37783 20.6 mm 13/16"</p>	 <p>LC-37786 22.2 mm 7/8"</p>
 <p>LC-37787 17.46 mm 11/16"</p>	 <p>LC-37799 17.4 mm 11/16"</p>	 <p>LC-37839 17.4 mm 11/16"</p>	 <p>LC-37840 17.4 mm 11/16"</p>
 <p>LC-37841 22.2 mm 7/8"</p>	 <p>LC-37842 23.8 mm 15/16"</p>	 <p>LC-37844 19.0 mm 3/4"</p>	 <p>LC-37846 19.0 mm 3/4"</p>

FOTOS CILINDROS DE RUEDA



Lusac











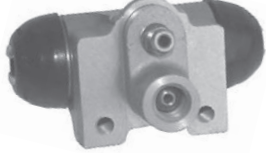
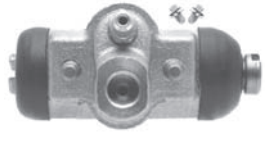
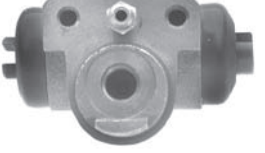

Raybestos
The best in brakes

CILINDROS DE RUEDA

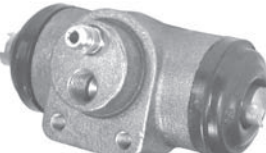
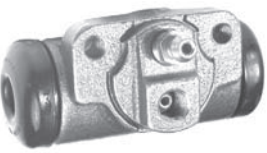
LC-37847 - LC-37863

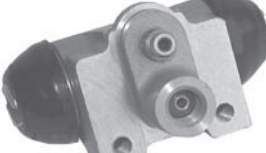
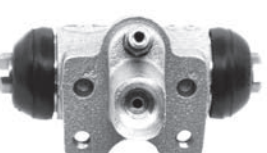
FOTOS CILINDROS DE RUEDA

 LC-37847 19.0 mm 3/4"	 LC-37848 19.0 mm 3/4"	 LC-37849 19.0 mm 3/4"	 LC-37850 15.8 mm 5/8"
 LC-37851 15.8 mm 5/8"	 LC-37852 23.8 mm 15/16"	 LC-37853 23.8 mm 15/16"	 LC-37854 22.2 mm 7/8"
 LC-37855 23.8 mm 15/16"	 LC-37856 22.2 mm 7/8"	 LC-37857 25.4 mm 1"	 LC-37858 20.6 mm 13/16"
 LC-37859 20.6 mm 13/16"	 LC-37860 19.0 mm 3/4"	 LC-37862 20.6 mm 13/16"	 LC-37863 19.0 mm 3/4"



Lusac



Raybestos
The best in brakes

CILINDROS DE RUEDA

LC-37864 - LC-37969

 <p>LC-37864 15.8 mm 5/8"</p>	 <p>LC-37865 19.0 mm 3/4"</p>	 <p>LC-37867 17.4 mm 11/16"</p>	 <p>LC-37869 15.8 mm 5/8"</p>
 <p>LC-37870 20.6 mm 13/16"</p>	 <p>LC-37871 20.6 mm 13/16"</p>	 <p>LC-37872 22.2 mm 7/8"</p>	 <p>LC-37944 25.4 mm 1"</p>
 <p>LC-37945 25.4 mm 1"</p>	 <p>LC-37946 25.4 mm 1"</p>	 <p>LC-37961 17.4 mm 11/16"</p>	 <p>LC-37962 17.4 mm 11/16"</p>
 <p>LC-37963 22.2 mm 7/8"</p>	 <p>LC-37967 19.0 mm 3/4"</p>	 <p>LC-37968 19.0 mm 3/4"</p>	 <p>LC-37969 19.0 mm 3/4"</p>

FOTOS CILINDROS DE RUEDA



Lusac



Raybestos
The best in brakes

CILINDROS DE RUEDA

LC-37970 - LC-40824

FOTOS CILINDROS DE RUEDA

 LC-37970 19.0 mm 3/4"	 LC-37973 20.6 mm 13/16"	 LC-37975 22.2 mm 7/8"	 LC-37976 22.2 mm 7/8"
 LC-37982 17.4 mm 11/16"	 LC-37984 17.4 mm 11/16"	 LC-37985 23.8 mm 15/16"	 LC-37986 19.0 mm 3/4"
 LC-37995 20.6 mm 13/16"	 LC-37996 20.6 mm 13/16"	 LC-37997 22.2 mm 7/8"	 LC-37999 23.8 mm 15/16"
 LC-40416 28.5 mm 1-1/8"	 LC-40417 28.5 mm 1-1/8"	 LC-40823 26.9 mm 1-1/16"	 LC-40824 26.9 mm 1-1/16"



Lusac



Raybestos
The best in brakes

CILINDROS DE RUEDA

LC-40951 - LC-45998

 LC-40951 28.5 mm 1-1/8"	 LC-40952 28.5 mm 1-1/8"	 LC-40965 25.4 mm 1"	 LC-41718 26.9 mm 1-1/16"
 LC-41719 26.9 mm 1-1/16"	 LC-42190 26.9 mm 1-1/16"	 LC-42191 26.9 mm 1-1/16"	 LC-43375 28.5 mm 1-1/8"
 LC-43376 28.5 mm 1-1/8"	 LC-45873 22.2 mm 7/8"	 LC-45960 30.1 mm 1-3/16"	 LC-45961 30.1 mm 1-3/16"
 LC-45995 28.5 mm 1-1/8"	 LC-45996 28.5 mm 1-1/8"	 LC-45997 28.5 mm 1-1/8"	 LC-45998 28.5 mm 1-1/8"

FOTOS CILINDROS DE RUEDA



Lusac



Raybestos
The best in brakes

CILINDROS DE RUEDA

LC-45999 - LC-51088

FOTOS CILINDROS DE RUEDA



LC-45999
23.8 mm 15/16"

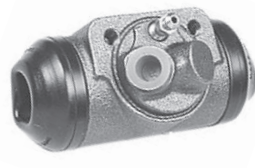

LC-46251
28.5 mm 1-1/8"



LC-46252
28.5 mm 1-1/8"

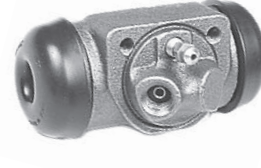

LC-48418
20.6 mm 13/16"

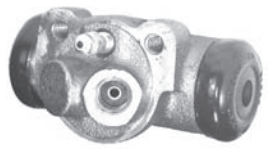

LC-48419
20.6 mm 13/16"



LC-49232
27.7 mm 1-3/32"



LC-49233
27.7 mm 1-3/32"



LC-49331
21.4 mm 27/32"



LC-49680
28.5 mm 1-1/8"



LC-49681
28.5 mm 1-1/8"



LC-50014
23.8 mm 15/16"



LC-50371
27.7 mm 1-3/32"

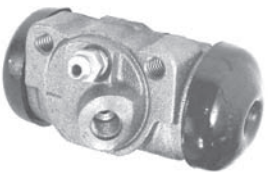

LC-50372
27.7 mm 1-3/32"



LC-51081
23.8 mm 15/16"



LC-51087
30.1 mm 1-3/16"



LC-51088
25.4 mm 1"



Lusac



Raybestos
The best in brakes

CILINDROS DE RUEDA

LC-51135 - LC-59240

 <p>LC-51135 38.1 mm 1-1/2"</p>	 <p>LC-51136 30.1 mm 1-3/16"</p>	 <p>LC-55674 38.1 mm 1-1/2"</p>	 <p>LC-55675 38.1 mm 1-1/2"</p>
 <p>LC-55890 27.7 mm 1-3/32"</p>	 <p>LC-55891 27.7 mm 1-3/32"</p>	 <p>LC-56407W 20.6 mm 13/16"</p>	 <p>LC-57146 25.4 mm 1"</p>
 <p>LC-57147 25.4 mm 1"</p>	 <p>LC-57150 41.3 mm 1-5/8"</p>	 <p>LC-57151 41.3 mm 1-5/8"</p>	 <p>LC-57152 41.3 mm 1-5/8"</p>
 <p>LC-57153 41.3 mm 1-5/8"</p>	 <p>LC-57850 38.1 mm 1-1/2"</p>	 <p>LC-57851 38.1 mm 1-1/2"</p>	 <p>LC-59240 23.8 mm 15/16"</p>

FOTOS CILINDROS DE RUEDA



Lusac









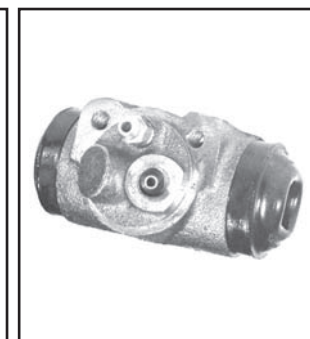
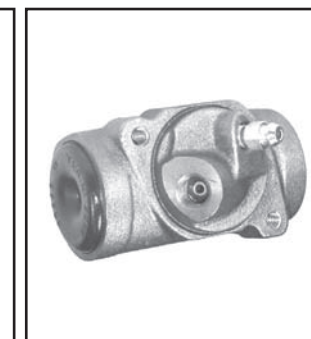
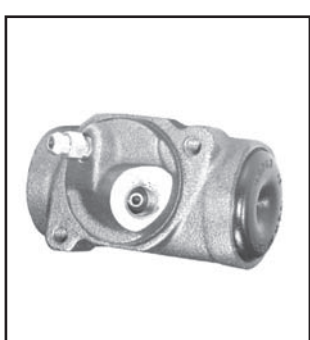

Raybestos
The best in brakes

CILINDROS DE RUEDA

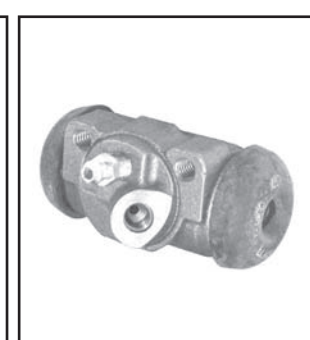
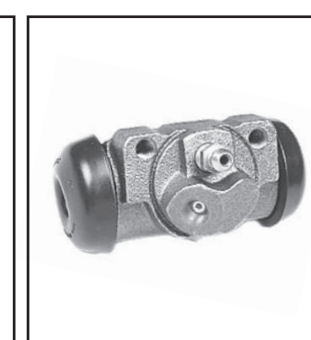
LC-59241 - LC-72258

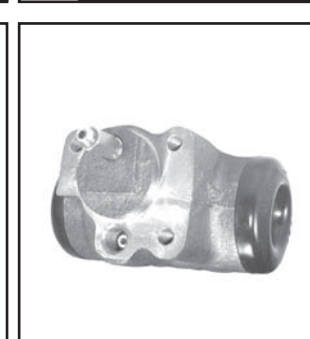
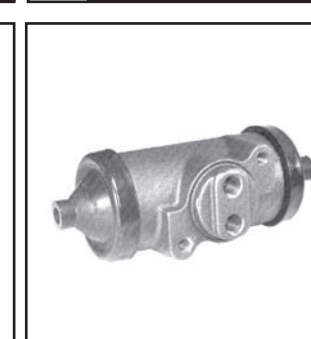
FOTOS CILINDROS DE RUEDA

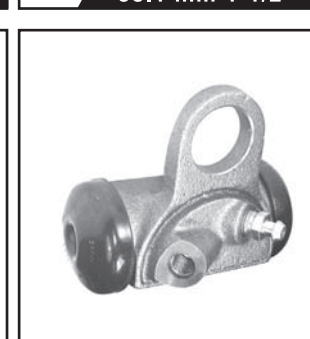
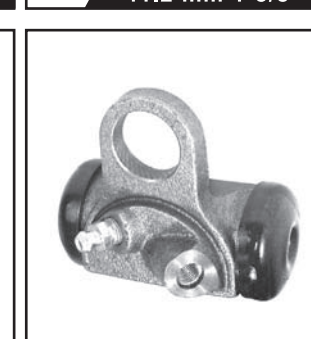
 LC-59241 23.8 mm 15/16"	 LC-71202 25.4 mm 1"	 LC-71203 25.4 mm 1"	 LC-71210 28.5 mm 1-1/8"
 LC-71211 28.5 mm 1-1/8"	 LC-71214 28.5 mm 1-1/8"	 LC-71215 28.5 mm 1-1/8"	 LC-71216 20.6 mm 13/16"
 LC-71217 20.6 mm 13/16"	 LC-71221 38.1 mm 1-1/2"	 LC-71222 38.1 mm 1-1/2"	 LC-71238 41.2 mm 1-5/8"
 LC-71940 28.5 mm 1-1/8"	 LC-71941 28.5 mm 1-1/8"	 LC-72257 28.5 mm 1-1/8"	 LC-72258 28.5 mm 1-1/8"









Lusac

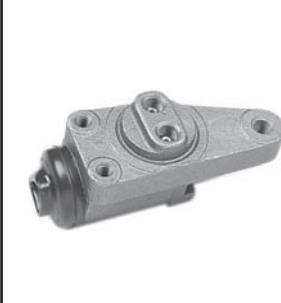
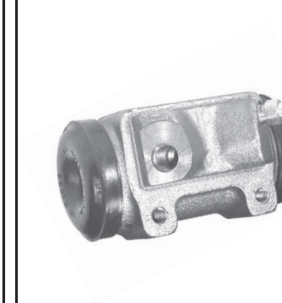
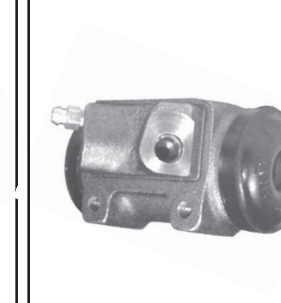

Raybestos
The best in brakes

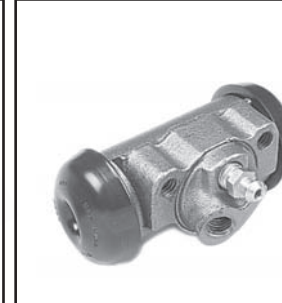
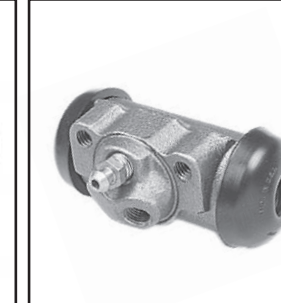
CILINDROS DE RUEDA

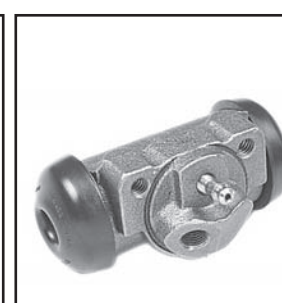
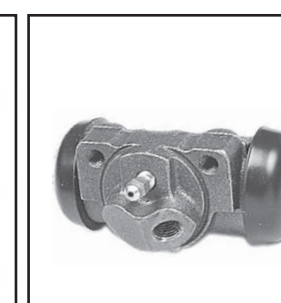
LC-73500 - LC-78745

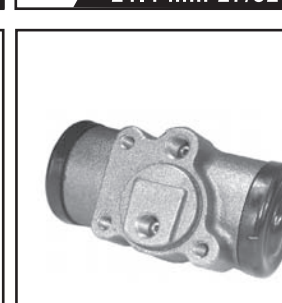
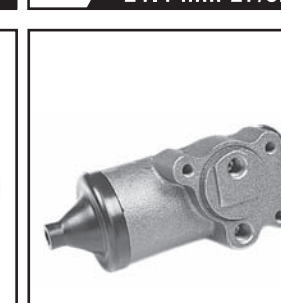
 <p>LC-73500 28.5 mm 1-1/8"</p>	 <p>LC-73501 28.5 mm 1-1/8"</p>	 <p>LC-73608 30.1 mm 1-3/16"</p>	 <p>LC-73609 30.1 mm 1-3/16"</p>
 <p>LC-73620 23.8 mm 15/16"</p>	 <p>LC-73621 23.8 mm 15/16"</p>	 <p>LC-73622 25.4 mm 1"</p>	 <p>LC-73623 25.4 mm 1"</p>
 <p>LC-73626 28.5 mm 1-1/8"</p>	 <p>LC-73627 28.5 mm 1-1/8"</p>	 <p>LC-78314 21.4 mm 27/32"</p>	 <p>LC-78315 21.4 mm 27/32"</p>
 <p>LC-78472 44.4 mm 1-3/4"</p>	 <p>LC-78743 38.1 mm 1-1/2"</p>	 <p>LC-78744 38.1 mm 1-1/2"</p>	 <p>LC-78745 38.1 mm 1-1/2"</p>

FOTOS CILINDROS DE RUEDA



Lusac



Raybestos
The best in brakes

CILINDROS DE RUEDA

LC-78974 - LC-96387

FOTOS CILINDROS DE RUEDA

 LC-78974 25.4 mm 1"	 LC-78975 25.4 mm 1"	 LC-79767 26.9 mm 1-1/16"	 LC-079768 30.1 mm 1-3/16"
 LC-79794 26.9 mm 1-1/16"	 LC-79795 26.9 mm 1-1/16"	 LC-79985 22.2 mm 7/8"	 LC-80186 20.6 mm 13/16"
 LC-80187 20.6 mm 13/16"	 LC-80918 26.9 mm 1-1/16"	 LC-80919 26.9 mm 1-1/16"	 LC-86000 28.5 mm 1-1/8"
 LC-90549 22.2 mm 7/8"	 LC-90550 19.0 mm 3/4"	 LC-93356 17.4 mm 11/16"	 LC-96387 23.8 mm 15/16"



Lusac



Raybestos
The best in brakes

CILINDROS DE RUEDA

LC-96399 - LC-108106

 LC-96399 17.4 mm 11/16"	 LC-96402 14.2 mm 9/16"	 LC-96613 20.6 mm 13/16"	 LC-99284 22.2 mm 7/8"
 LC-101604 19.0 mm 3/4"	 LC-101610 23.8 mm 15/16"	 LC-103223 27.7 mm 1-3/32"	 LC-103224 27.7 mm 1-3/32"
 LC-104384 17.4 mm 11/16"	 LC-106006 22.2 mm 7/8"	 LC-106315 23.8 mm 15/16"	 LC-106922 26.9 mm 1-1/16"
 LC-106923 26.9 mm 1-1/16"	 LC-107475 14.2 mm 9/16"	 LC-107476 15.8 mm 5/8"	 LC-108106 22.2 mm 7/8"









FOTOS CILINDROS DE RUEDA

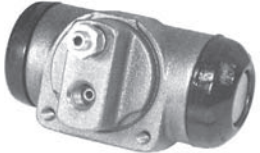

CILINDROS DE RUEDA

LC-108107 - LC-370018

FOTOS CILINDROS DE RUEDA

 LC-108107 22.2 mm 7/8"	 LC-109532 19.0 mm 3/4"	 LC-110260 19.0 mm 3/4"	 LC-112341 22.2 mm 7/8"
 LC-112365 25.4 mm 1"	 LC-113757 30.1 mm 1-3/16"	 LC-113758 30.1 mm 1-3/16"	 LC-114197 15.8 mm 5/8"
 LC-116224 30.1 mm 1-3/16"	 LC-116263 28.5 mm 1-1/8"	 LC-116359 25.4 mm 1"	 LC-0116366 17.4 mm 11/16"
 LC-116384 16.0 mm	 LC-117345 19.0 mm 3/4"	 LC-129564 25.4 mm 1"	 LC-370018 17.8 mm 45/64"



Lusac



Raybestos
The best in brakes

CILINDROS DE RUEDA

LC-370027 - LC-370088

 LC-370027 19.0 mm 3/4"	 LC-370031 19.0 mm 3/4"	 LC-370042 28.5 mm 1-1/8"	 LC-370043 28.5 mm 1-1/8"
 LC-370050 20.6 mm 13/16"	 LC-370051 20.6 mm 13/16"	 LC-370055 22.2 mm 7/8"	 LC-370061 20.6 mm 13/16"
 LC-370073 22.2 mm 7/8"	 LC-370074 22.2 mm 7/8"	 LC-370077 23.8 mm 15/16"	 LC-370080 20.6 mm 13/16"
 LC-370081 17.4 mm 11/16"	 LC-370083 25.4 mm 1"	 LC-370087 22.2 mm 7/8"	 LC-370088 22.2 mm 7/8"

FOTOS CILINDROS DE RUEDA



CILINDROS DE RUEDA

LC-370091 - LC-370131

FOTOS CILINDROS DE RUEDA

 <p>LC-370091 22.2 mm 7/8"</p>	 <p>LC-370092 22.2 mm 7/8"</p>	 <p>LC-370093 20.6 mm 13/16"</p>	 <p>LC-370094 23.8 mm 15/16"</p>
 <p>LC-370105 20.6 mm 13/16"</p>	 <p>LC-370106 23.8 mm 15/16"</p>	 <p>LC-370111 23.8 mm 15/16"</p>	 <p>LC-370112 19.0 mm 3/4"</p>
 <p>LC-370117 22.2 mm 7/8"</p>	 <p>LC-370121 22.2 mm 7/8"</p>	 <p>LC-370123 20.6 mm 13/16"</p>	 <p>LC-370127 20.6 mm 13/16"</p>
 <p>LC-370128 25.4 mm 1"</p>	 <p>LC-370129 20.6 mm 13/16"</p>	 <p>LC-370130 22.2 mm 7/8"</p>	 <p>LC-370131 19.0 mm 3/4"</p>



Lusac



Raybestos
The best in brakes

CILINDROS DE RUEDA

LC-370132 - LC-370174

 LC-370132 19.0 mm 3/4"	 LC-370133 17.4 mm 11/16"	 LC-370139 19.0 mm 3/4"	 LC-370142 15.8 mm 5/8"
 LC-370143 22.2 mm 7/8"	 LC-370146 19.0 mm 3/4"	 LC-370148 23.8 mm 15/16"	 LC-370149 19.0 mm 3/4"
 LC-370152 19.0 mm 3/4"	 LC-370153 22.2 mm 7/8"	 LC-370154 22.2 mm 7/8"	 LC-370155 19.0 mm 3/4"
 LC-370157 15.8 mm 5/8"	 LC-370158 22.2 mm 7/8"	 LC-370159 22.2 mm 7/8"	 LC-370174 22.2 mm 7/8"

FOTOS CILINDROS DE RUEDA



Lusac



Raybestos
The best in brakes

CILINDROS DE RUEDA

LC-370176 - LC-370382

FOTOS CILINDROS DE RUEDA

 <p>LC-370176 20.6 mm 13/16"</p>	 <p>LC-370180 23.8 mm 15/16"</p>	 <p>LC-370181 26.9 mm 1-1/16"</p>	 <p>LC-370182 19.0 mm 3/4"</p>
 <p>LC-370183 23.8 mm 15/16"</p>	 <p>LC-370185 19.0 mm 3/4"</p>	 <p>LC-370186 20.6 mm 13/16"</p>	 <p>LC-370187 22.2 mm 7/8"</p>
 <p>LC-370189 30.1 mm 1-3/16"</p>	 <p>LC-370190 23.8 mm 15/16"</p>	 <p>LC-370191 20.6 mm 13/16"</p>	 <p>LC-370195 19.0 mm 3/4"</p>
 <p>LC-370301 19.0 mm 3/4"</p>	 <p>LC-370361 19.0 mm 3/4"</p>	 <p>LC-370366 19.0 mm 3/4"</p>	 <p>LC-370382 22.0 mm</p>



Lusac



Raybestos
The best in brakes

CILINDROS DE RUEDA

LC-370384 - LC-41102B96

 <p>LC-370384 22.0 mm</p>	 <p>LC-3700900 19.0 mm 3/4"</p>	 <p>LC-3700901 22.2 mm 7/8"</p>	 <p>LC-3700902 22.2 mm 7/8"</p>
 <p>LC-3700904 22.3 mm 7/8"</p>	 <p>LC-3700905 19.0 mm 3/4"</p>	 <p>LC-3700908 19.0 mm 3/4"</p>	 <p>LC-3700912 22.2 mm 7/8"</p>
 <p>LC-3700913 22.2 mm 7/8"</p>	 <p>LC-3700914 17.4 mm 11/16"</p>	 <p>LC-3700915 22.2mm 7/8"</p>	 <p>LC-37009016 22.2 mm 7/8"</p>
 <p>LC-37009017 22.2 mm 7/8"</p>	 <p>LC-41100B96 25.4 mm 1"</p>	 <p>LC-41101B96 25.4 mm 1"</p>	 <p>LC-41102B96 25.4 mm 1"</p>

FOTOS CILINDROS DE RUEDA



CILINDROS DE RUEDA

LC-41103B96 - LC-44100U48

FOTOS CILINDROS DE RUEDA

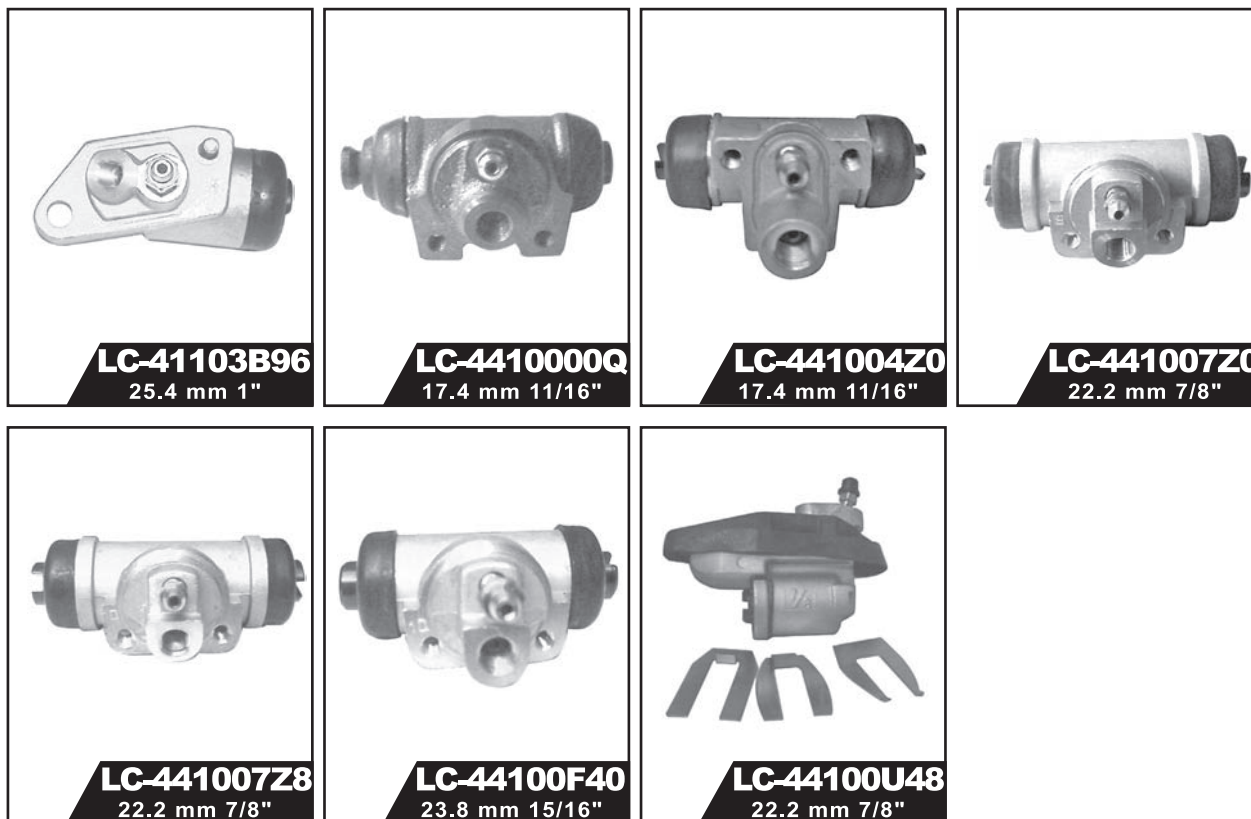

- Amplia cobertura de números de parte para vehículos nacionales e importados.
- LUSAC ofrece castings tanto de Duraluminio como de hierro en sus cilindros maestros, ajustándose a las necesidades del equipo original.
- Material de excelentes características mecánicas, que permiten a los cilindros maestros LUSAC responder ante las más altas exigencias de presión y temperatura.
 - Interiores con acabado tipo espejo que permite un sellado perfecto evitando fugas.
- Resortes interiores de acero templado con recubrimiento antioxidante que ofrecen larga vida útil.
- Sometemos nuestras gomas a una prueba rigurosa de 70 mil ciclos, en la que se manejan valores elevados de temperatura y presión. Esta prueba es difícilmente superada por nuestros competidores.
- Lubricación interna en los repuestos de los cilindros maestros, que previenen la oxidación durante su almacenamiento, evitando que se dañen las gomas, asegurando un correcto funcionamiento, durante un largo tiempo.